

Field Research Software™

Classic GrainGage™ FRS Laptop



Reference Guide

Juniper Systems and Allegro Field PC are registered trademarks of Juniper Systems, Inc. in the United States. Allegro CX, Archer Field PC, Field Research Software, FRS, FRS Note Taking, FRS Plot Harvest Data Modules, GrainGage, Classic GrainGage, USB/Power Dock, and the Juniper Systems logos are trademarks of Juniper Systems, Inc.

Reproduction of this reference guide without the written permission of Juniper Systems, Inc. is not allowed.

Information in this document is subject to change without notice.
© February 2010, Juniper Systems, Inc. All rights reserved.

P/N 22621-01

Contents

| | | |
|----------|--|-----------|
| | Software License Agreement | 5 |
| 1 | Introduction to FRS Harvest on a Laptop | 7 |
| | Getting Started: How to install FRS Harvest | 9 |
| | Registering FRS Laptop | 10 |
| 2 | Setting Up FRS Harvest™ | 13 |
| 3 | Calibrating and Preparing for Harvest | 17 |
| | To verify weight calibrations..... | 18 |
| | Moisture Sensor | 22 |
| | Timers | 36 |
| | Actuators..... | 37 |
| | Setup File..... | 38 |
| 4 | Diagnostics Menu | 41 |
| | Load Cell..... | 43 |
| | Moisture..... | 46 |
| | LED Codes on the EM Grain Moisture Sensor | 47 |
| | Level Detect Sensor..... | 50 |
| | Actuators..... | 51 |
| | Print Calibrations..... | 52 |
| 5 | Creating Traits and Templates for Harvest | 53 |
| | Create harvest traits | 54 |
| | Create a Harvest Template..... | 57 |

| | | |
|----------|--|-----------|
| 6 | Harvest Data Collection | 61 |
| | Collection Screen | 62 |
| | Preparing to collect harvest data | 64 |
| | Harvest Sequence | 68 |
| 7 | DataLink for FRS | 71 |
| | DataLink Utilities | 80 |
| | Backup Log for Harvest Modules | 82 |
| 8 | General Care and Maintenance | 85 |
| | Classic GrainGage Regular Maintenance | 86 |
| | Load Cell Replacement Procedures | 94 |
| | GrainGage Chamber Installation | 102 |
| | Return for Repair Procedure | 105 |
| 9 | Appendix | 99 |
| | Appendix A: Warranty | 100 |
| | Appendix B: Mounting Diagrams | 108 |
| | Appendix C: Cable Wiring Diagrams for the HM800 | 112 |

Software License Agreement

Manufacturer Agreement

This Software License Agreement is between the end-user and Juniper Systems, Inc. (manufacturer). Please read the following terms and conditions before using Field Research Software with a device. This agreement supersedes any prior agreement, written or oral.

Granting of License

The manufacturer grants, under the following terms and conditions, a non-exclusive license to use Field Research Software.

Ownership

Juniper Systems, Inc. retains the title to and ownership of the software plus any copies made of the software.

Software Use

The FRS license and registration are only valid on one device per licensed copy. To purchase additional license copies, contact the manufacturer. You may make one copy of the software to be stored as a backup.

Copyright

Field Research Software is copyrighted by Juniper Systems, Inc. You may not rent, lease, lend, sub-license, modify, or disassemble this program. The associated documentation may not be reproduced without written permission.

Term

This License is in effect until terminated. It will be terminated under one of the following conditions:

- You destroy all copies of the software and documentation.
- You return all copies of the software and documentation to us.
- You fail to comply with any provisions of the License Agreement.

Acceptance or Disagreement

Use of the software in any manner indicates your acceptance and acknowledgment of the terms and conditions of this agreement. If you do not agree with any of the terms and conditions, do not use the software. Return the disk and documentation to the manufacturer. If the software was installed on the mobile device at the factory, you must delete it.



CHAPTER 1
**INTRODUCTION TO
FRS *HARVEST* ON A
LAPTOP**

Getting Started: How to install FRS *Harvest*
Registering FRS Laptop

Introduction to FRS *Harvest on a Laptop*

Designed by seed researchers, the Windows-based Field Research Software™ (FRS) helps seed researchers and agriculture scientists perform data collection tasks on research plots.

The Classic GrainGage™ is employed on combines to record weight, moisture, and test weight on grains. It aids research scientists by automating data collection. This Field Reference Guide helps you through the setup, calibration, and harvest with the Classic GrainGage.

This guide also outlines the operation of the Field Research Software Harvest module. The FRS Harvest module is a component of the FRS Note Taking™ application. This Field Reference Guide assumes the user is familiar with the operation of FRS Note Taking. For more information, see the FRS Note Taking Field Reference Guide.

FRS software for a laptop is designed so you can either use a mouse or the keyboard. Function keys, arrow keys, the Enter key, and the Tab key are designed to help you move the cursor through the software and make selections.



Figure 1-1: Classic GrainGage

Getting Started: How to install FRS Harvest

For instructions on installing the latest FRS Harvest software onto your handheld, follow these steps:

1. Visit our website at ***www.harvestmaster.com***.
2. Select ***Support***, then select ***Downloads***.
3. Choose the version of FRS and the Classic GrainGage module for Windows software from the appropriate menu.

Registering FRS Laptop

When registering FRS Laptop, the following FRS Registration Form will appear.

The screenshot shows a window titled "Registration" with a blue border. Inside, the text reads: "Please go to the website or call customer service with this unique ID and serial number to obtain your unlock code." Below this, there are three input fields: "Unique ID:" with the value "FR20-001C-238D-4B5F", "Serial Number:" with an empty box and a red "X" to its right, and "Unlock Code:" with two empty boxes and a red "X" to its right. At the bottom, there are two buttons: "Demo" on the left and "Continue" on the right.

Figure 1-2: Registration form

Before filling out this form, go to our Web site at www.harvestmaster.com and complete the Online Software Registration form. When asked for the software serial number, enter the serial number from your software license card. Next enter The Unique ID from the FRS Registration Form that appeared when FRS was first launched. See Figure 1-2. When the form is filled out, push the Register Software button. An Unlock Code will then be emailed to you.

Enter the Software Serial Number and the Unlock Code on the FRS Registration Form. The code is case sensitive so enter capital and lower case letters as shown. Write down the Unlock Code and keep it for future reference. The Xs on the screen will change to check marks when the screen is

properly filled out. Select Continue and you'll get a message that indicates that FRS is now registered.

DEMO mode can be used before registering to try out the software. It is fully functional with the exception that no data can be exported until it is registered.

Chapter 1



CHAPTER 2
SETTING UP FRS
HARVEST™

Setting Up FRS Harvest™

Follow these steps to enable your Classic GrainGage to work with FRS *Harvest*.

1. Make sure the cables between the control device and the laptop are set up properly so the software and hardware can communicate. For details about cable placement, see *Appendix C: Cable Wiring for the HM800*.
2. From the Main FRS Screen, select Setup (F3).

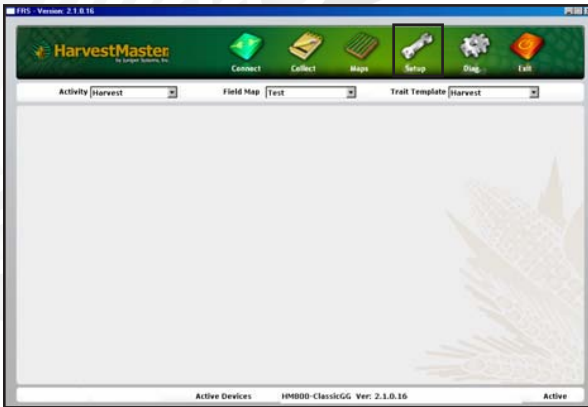

Figure 2-1: Choose Setup on the Main FRS Screen

3. Select **Manage Devices** either with the mouse or using the up or down arrow keys and pressing the Enter key.



Figure 2-2: Setup menu with Manage Devices selected

4. In the Devices screen shown below, enable the Twin or Single High Capacity GrainGage.

Note: Only one device can be enabled at a time.

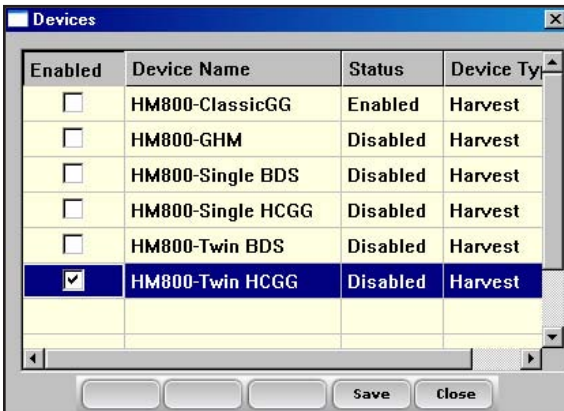
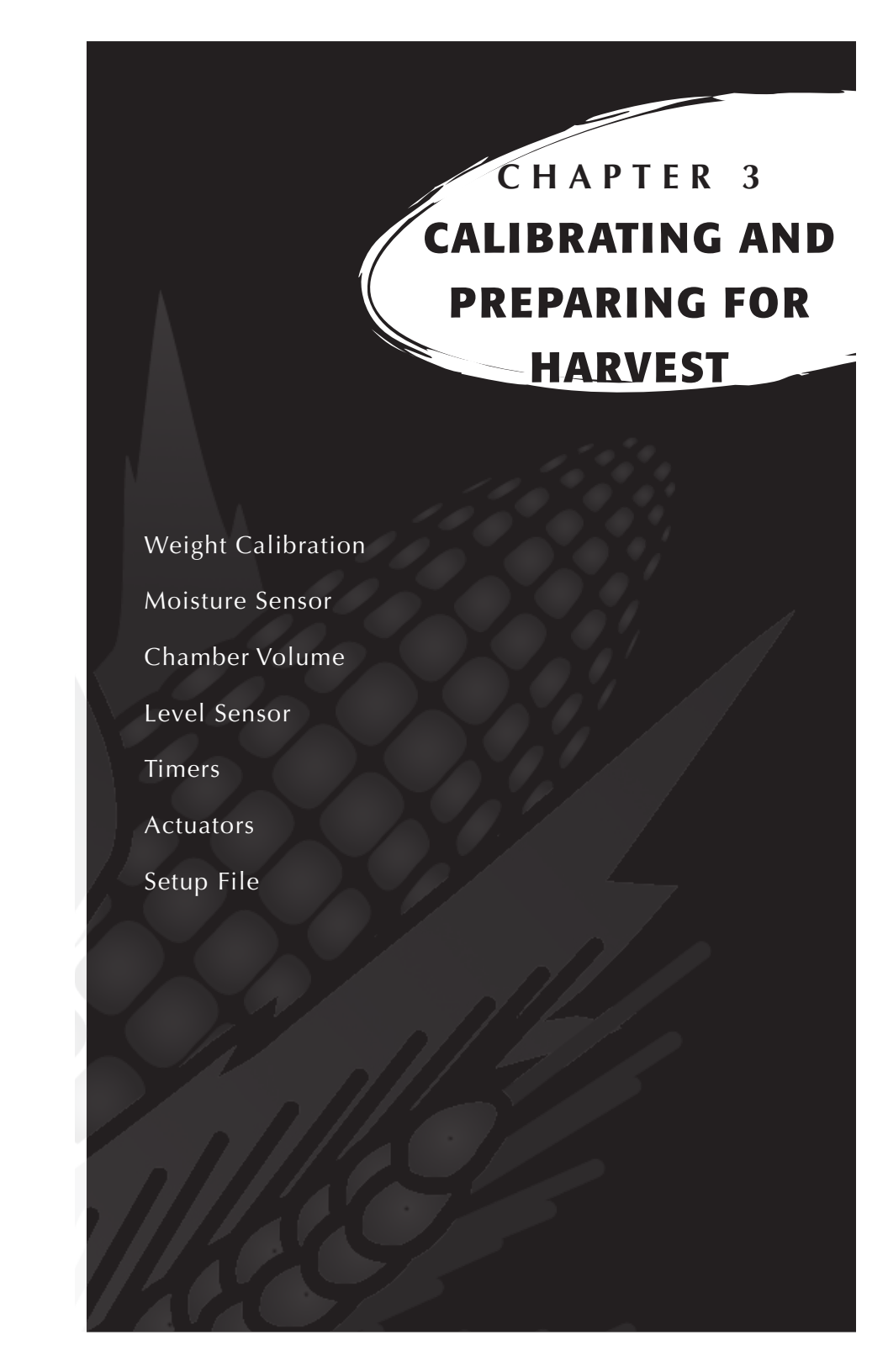

Figure 2-3: Devices screen showing the HM800-Twin HCGG as enabled

Chapter 2

5. Select **Save** (F4) and **Exit** (F5). The software begins to load and checks to see if hardware devices are connected. Wait until the software has finished loading before proceeding to the next chapter.

Select units of measurement, either English or Metric.
The default is English.



CHAPTER 3

CALIBRATING AND PREPARING FOR HARVEST

Weight Calibration

Moisture Sensor

Chamber Volume

Level Sensor

Timers

Actuators

Setup File

Calibrating and Preparing the Classic GrainGage for Harvest

This chapter explains how to calibrate and set up your Classic GrainGage to work with FRS Harvest. The sections below describe the first- and second-level menu options in the Setup menu under Classic Graingage Setup.

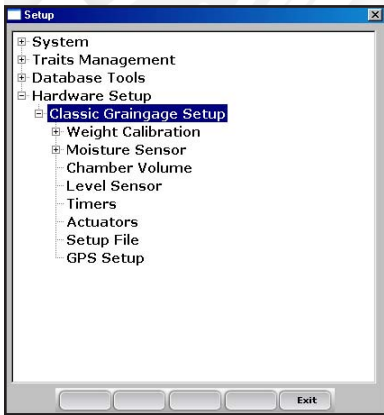

Figure 3-1: This chapter explains the options under Classic Graingage Setup in the Setup menu

To verify weight calibrations.

In diagnostics, select Load cell. Place known weight of approximately five lb on weigh pan as close to the center of the weigh pan as possible. Record the weight reading. If it is different from the known weight, complete the following steps to recalibrate the weight reading.

1. From the main FRS screen, select **Setup** (F3) > **Hardware Setup** > **Classic Graingage** > **Weight calibration** > **Edit Weight Calibration**.

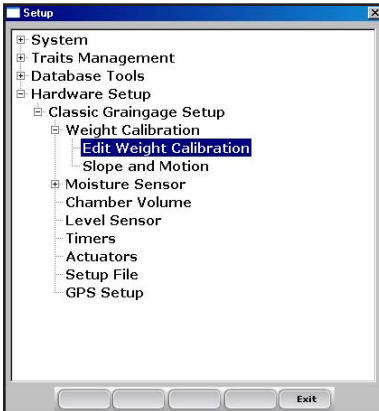

Figure 3-2: Setup screen with Edit Weight Calibration

2. Record Weight Calibration Coefficient value.

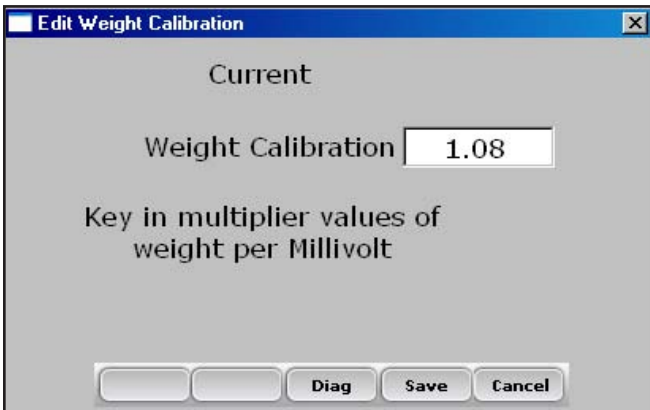

Figure 3-3: Edit Weight Calibration screen

3. Adjust the weight calibration using the following equations.

The HM800, use the following equation and example.

**New Weight Cal Coefficient =
Actual Weight/Measured Weight * Current Coefficient**

Example: 5.187lbs/9.63 lbs * 2.01 = 1.083

4. Replace the current Weight Calibration Coefficient with the calculated value.
5. In diagnostics from the main screen, select Load Cell and Tare weight.
6. Place known weight on weigh pan where it was placed previously and verify weight reading being displayed.

Note: Typical coefficient for HM800 typical coefficient is 1.08

Slope and Motion

The Slope and Motion Sensor refers to patented technology used to eliminate errors created by combine vibrations. The sensor lets you collect weight readings while the combine is in motion. To set the sensor, follow these steps:

1. From the Setup menu, select **Hardware Setup > Classic Graingage Setup > Weight Calibration**, then arrow down or select **Slope and Motion**.

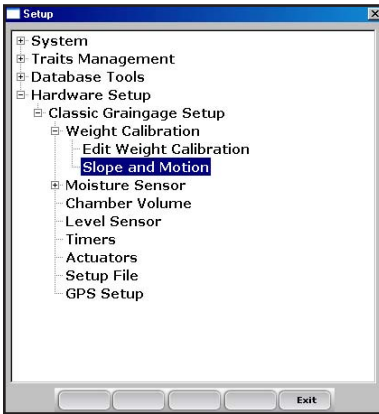

Figure 3-4: Setup menu with Slope and Motion selected

2. **Important:** Check to make sure—

- the shipping stop on the Slope and Motion Sensor is screwed out

Shipping stop screwed out as far as it will go.



- the combine is on a level surface with the thresher
 - the motor is turned off
3. Key in the reference weight with the combine still and level. The default value to enable the Slope and Motion Sensor is 4.0 for the reference weight. For metric, enter the equivalent of 4.0 lb or 1.814 kg.

Note: Lighter weights are available for some applications. If the sensor is equipped with a lighter weight, be sure to enter the weight written on the front of the box.

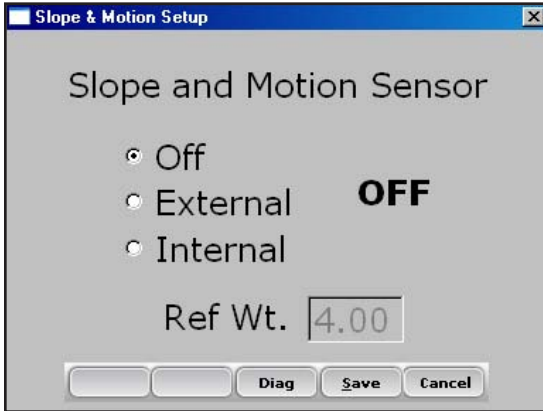

Figure 3-5: Slope and Motion screen

4. After selecting the **Internal** radio button, select **Save** (F4).
5. To disable the Slope and Motion Sensor, select Off then select **Save** (F4).

Moisture Sensor

The Classic GrainGage system uses the EM Grain Moisture sensor for moisture. To view or modify the moisture curves select **Moisture Sensor > Moisture Curve**.

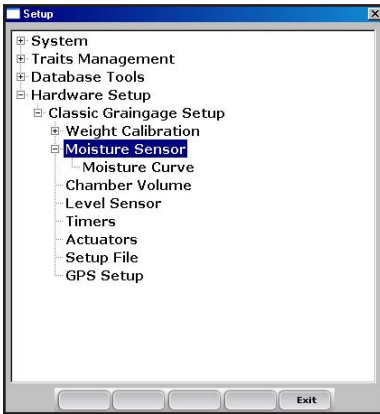

Figure 3-6: Setup screen with Moisture Sensor selected

Moisture Curve

Editing a moisture curve

To edit a moisture curve, follow these steps.

1. Select **Setup** (F3), then choose **Hardware Setup > Classic Graingage Setup > EM Sensor > Moisture curve.**

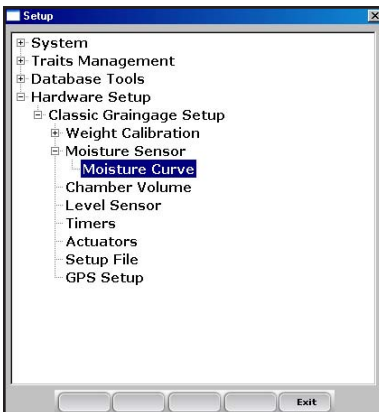

Figure 3-7: Setup screen with Moisture Curve screen selected

The Moisture Curve screen appears, listing any existing moisture curves and giving you the option to edit, delete, or copy moisture curves. Each of these actions is described in more detail below.

Note: The check mark next to one of the curves indicates the curve most recently used.

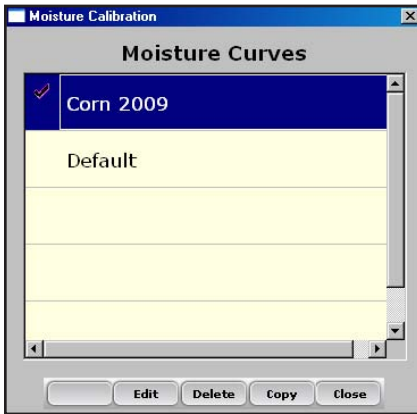

Figure 3-8: Moisture Calibration main screen

The Moisture Calibration screen lists all moisture curves that have been created. One of the curves is a **Default** grain moisture sensor curve that comes with FRS. It can be copied but not modified. The default curve consists of a set of known data points, which the system uses when making the moisture measurement on a sample of grain. When plotted in a spreadsheet, the default curve appears like the graph (see Figure 3-9).

Default Moisture Curve for EM Sensor

| Moist % | MV |
|---------|------|
| 0.00% | 0.00 |
| 10.00% | 1.22 |
| 13.00% | 1.61 |
| 16.00% | 1.93 |
| 19.00% | 2.19 |
| 22.00% | 2.41 |
| 25.00% | 2.60 |
| 28.00% | 2.77 |
| 31.00% | 2.93 |
| 34.00% | 3.07 |
| 37.00% | 3.19 |
| 40.00% | 3.30 |

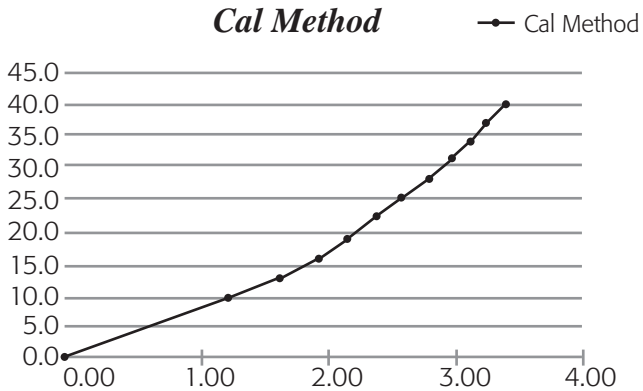

Figure 3-9: Default moisture curve as it appears in a spreadsheet (top) and as it appears in a graph (bottom)

To check moisture, choose **Diags** (F4) on the main FRS screen then select **Moisture**. Record the Rel VItS and the Moisture (%) from each sample that has been cycled

through the grain gage. Compare the Moisture (%) reading with a known percent moisture from a standard.

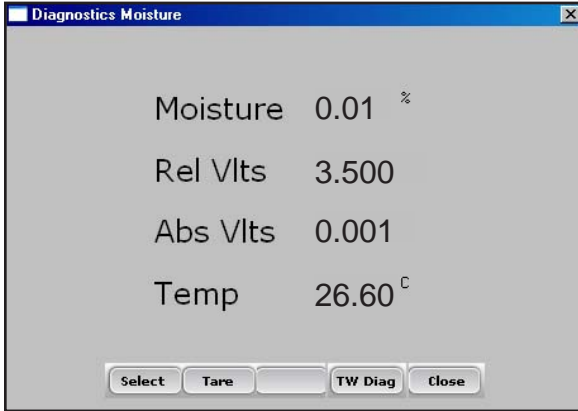

Figure 3-10: Diagnostics Moisture screen

2. Adjust the moisture curve by adjusting individual points in the curve or by adjusting the value of the Calibration Temperature. The following sections explain how to make adjustments to individual points, how to adjust the moisture grain temperature, how to delete a curve, and how to copy a curve.

Note: We recommend creating a different moisture curve for each different grain type. A custom spreadsheet to aid in adjusting your moisture calibration can be found on the Juniper Systems web site. This spreadsheet helps you adjust the points on the moisture curve to match your system.

To access the spreadsheet, go to www.harvestmaster.com and choose **Support > Downloads**. Click on the link called **EM Moisture Sensor Curve Calculator** to view the spreadsheet.

Adjusting Individual Points

To adjust individual points, follow these steps:

1. Select the moisture curve you want to edit and select **Edit** (F2).

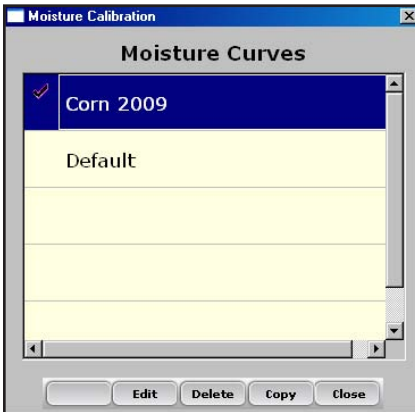
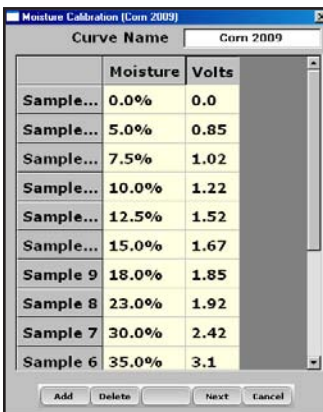

Figure 3-11: Moisture Calibration main screen

2. Select the percent or volts you want to adjust, and enter the new values.



| Curve Name | Corn 2009 | |
|------------|-----------|-------|
| | Moisture | Volts |
| Sample... | 0.0% | 0.0 |
| Sample... | 5.0% | 0.85 |
| Sample... | 7.5% | 1.02 |
| Sample... | 10.0% | 1.22 |
| Sample... | 12.5% | 1.52 |
| Sample... | 15.0% | 1.67 |
| Sample 9 | 18.0% | 1.85 |
| Sample 8 | 23.0% | 1.92 |
| Sample 7 | 30.0% | 2.42 |
| Sample 6 | 35.0% | 3.1 |

Figure 3-12: You can edit Moisture or Volts for a sample

3. Select **Next** (F4) to save your changes to the moisture curve and advance to the Moisture Correction and Temperature screen.

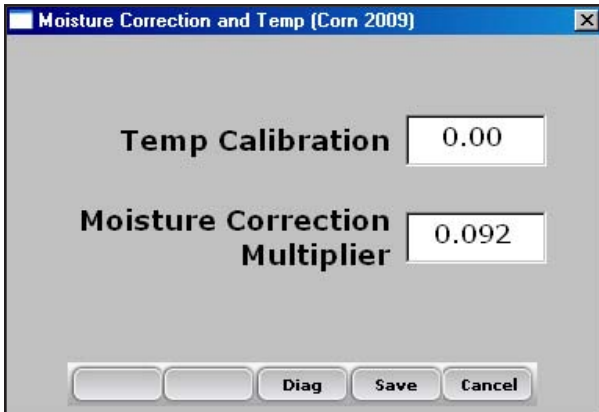

Figure 3-13: Moisture Calibration Correction and Temperature screen

We recommend setting Temp Calibration to the current temp reading found in the diagnostics menu.

Note: When grain moisture readings are harvested at a different temperature than the temperature during the original calibration, the grain moisture measurement needs to be corrected to adjust for this difference. The Classic Graingage System automatically makes this moisture correction based on the Temp Calibration and Moisture Correction Multiplier found in the screen above.

4. When you are finished editing your moisture curve, select **Save** (F4) to exit and save your changes.

Adjusting the Grain Moisture Temperature

You can also use the temperature calibration to make small adjustments to moisture readings taken by the system. To change the temperature calibration to match your grain samples, follow these steps:

1. From the Main FRS screen, Select **Setup** (F3), then **Hardware Setup** > **Classic Graingage Setup** > **EM Sensor (Moisture)** > **Moisture Curve**.
2. Select a moisture curve.
3. Select **Edit** (F2) or **Copy** (F4).
4. Select **Next** (F4). The Moisture Correction and Temperature screen appears.

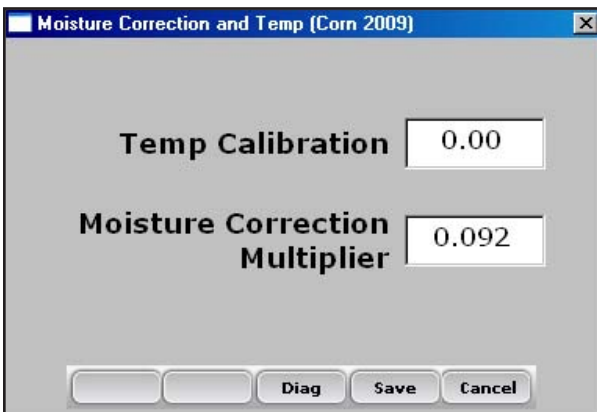

Figure 3-14: Moisture Correction and Temperature screen for the “corncalc” curve

Even though the moisture correction is automatic, changing the Temp Calibration shifts all moisture readings up or down, depending on if the temperature was increased or decreased. If

you find that your new moisture reading is consistently high over the whole range, you can lower the calibration temperature to decrease all moisture readings. You can also raise the calibration temperature if your moisture is consistently too low. This is an easy way to fine-tune the moisture curve after calibration.

Follow these steps to calculate the proper temperature adjustment:

1. If the Classic provides a different moisture value than your actual moisture value (e.g., 19.5% instead of 18.5%) and you'd like to adjust it, use this formula to figure out the calibration value:

$$\frac{(\text{Actual Moisture} - \text{Classic Moisture})}{\text{Moisture Correction Multiplier}} = \text{Mstr. Temperature Calibration}$$

$$\text{Example: } 18.5\% - 19.5\% / 0.092 = -10.87 \text{ C}$$

2. Next, add this value to your existing temperature.

Note: If the calibration value you calculated in Step 1 is negative as in the example above, keep the negative sign.

In this example, assume the existing temperature calibration is 27 C:

$$\text{Temp Calibration} + \text{Mstr Temp Cal} = \text{New Temp Calibration}$$

$$\text{Example: } 27.0 + (-10.87) = 16.13$$

3. Save any changes you made to the settings on the Moisture Correction and Temperature screen by clicking **Save** (F4). You can check the moisture calibration by clicking **Diag** (F3) before saving your changes.

Deleting a Curve

The **Delete** option in the Moisture Curve menu allows you to remove unwanted moisture curves. To delete an unwanted moisture curve, follow these steps:

1. Select the curve you want to delete and select **Delete** (F3).

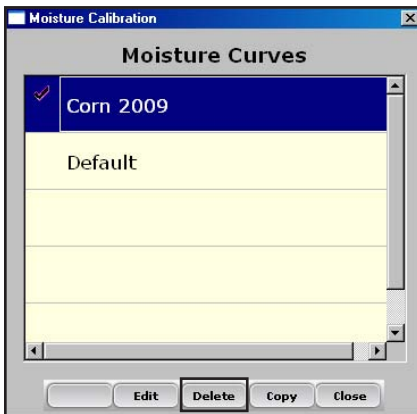

Figure 3-15: Delete a moisture curve by selecting it and clicking Delete (F3)

2. Confirm the delete by selecting **Yes** or **No**.

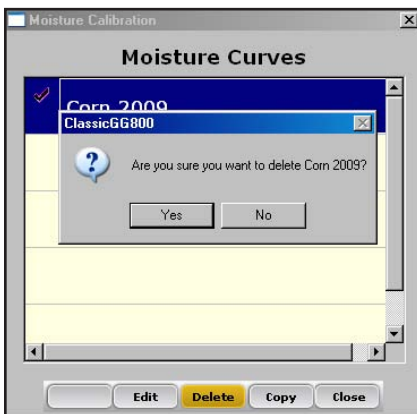

Figure 3-16: Warning screen requires you to choose Yes or No

Copying a Curve

The Default Moisture cannot be modified. To make changes to this curve, you must first make a copy of it. Follow these steps to copy a curve:

1. Select the moisture curve you want to copy or rename and then select **Copy** (F4).
2. Type in the new name of the moisture curve, make any desired changes, then select **Next** (F4).
3. Select **Save** (F4) to save the file and exit the screen.

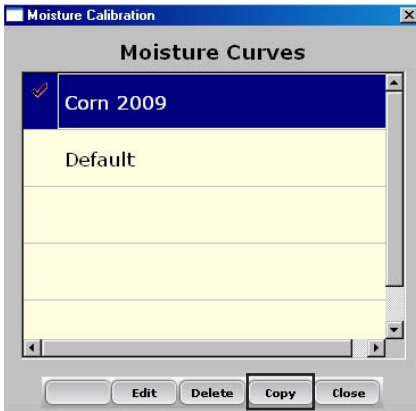

Figure 3-17: Copy a moisture curve by selecting it and clicking Copy (F4)

Test Weight Chamber Volume

To view or change the test weight chamber volume, follow these steps:

1. Choose Setup (F3) on the main FRS screen, then select Hardware **Setup** > **Classic GrainGage Setup** > **Chamber Volume**.

2. The test weight chamber volume is used in the calculation of test weight of the grain sample. Default values for the chamber volume are as follows

| Chamber Size | Cubic Inches | Cubic cm. |
|---------------------|---------------------|------------------|
| 3.5 liter | 209 cu inches | 3441 |
| 1.5 liter | 89 cu inches | 1458 |

3. To verify test weight accuracy take a grain sample and verify test weight from a known test weight measurement device. Cycle the grain sample through the GrainGage to get a measured test weight. If the test weight measured by the GrainGage does not match the test weight from a standard the chamber volume can be adjusted.
4. To adjust the test weight reading from the GrainGage use the following formula

$$\text{New Chamber Volume} = \frac{\text{measured test weight}}{\text{actual test weight}} * \text{chamber volume}$$

$$\text{Example: } 56.2 \text{ lbs/bu} / 58.8 * 89 = 85 \text{ cu inches.}$$

Type the new test weight chamber volume into the text box. For metric conversion, the test chamber and test weight should be in cu cm and kg/hl.

Level Sensor

To view or change the settings of the level detect sensor, follow these steps:

1. Choose **Setup** (F3) on the main FRS screen, then select **Hardware Setup > Classic Graingage Setup > Level Sensor**.

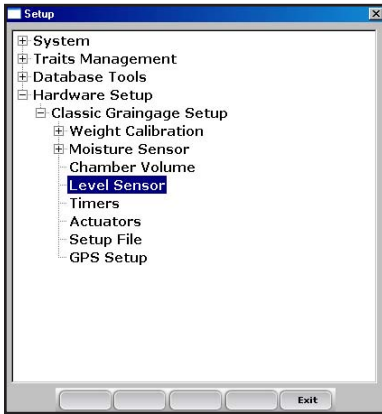

Figure 3-18: Choose Level Sensor from the Setup menu

The Level Detect Sensor Settings screen appears (see Figure 3-19).

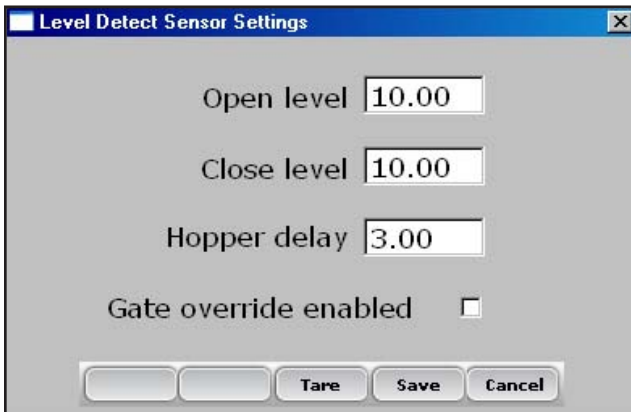

Figure 3-19: Level Detect Sensor Settings main screen

2. The GrainGage uses a level sensor to determine when to initiate the cycling of the GrainGage. The Open and Close levels are settings that determine the amount of grain in the hopper needed to trigger the GrainGage to cycle. The higher the level setting the more grain required to start the cycle sequence.

Note: Typical values for an HM800 Classic GrainGage are to set both levels at 10.

3. As grain flows into the hopper it fills around the level detect. When the grain gets high enough to trip the Open Level triggers the hopper door opens. The grain has to fill up the middle or test chamber and fill up the hopper to trigger the Close level in order for the hopper door to close.

Hopper Delay

The Hopper Delay setting is a timer used to delay the opening of the hopper door the very first time the Open Level has been triggered. This allows more grain to fill the hopper so that the close level detect will be triggered as soon as the hopper opens. This minimizes excessive packing of grain during this first cycle.

For example: if the hopper delay is set to three, the GrainGage will wait three seconds after the level detect has triggered the open level before the gate will open.

The ***Gate override enable*** is not implemented at this time.

Timers

The Timer screen is used to adjust various timers used with the system. Each of these timers can be adjusted using the Timer Setup screen, which is available by choosing Setup (F3) from the main FRS screen, then selecting **Hardware System** > **Classic Graingage Setup** > **Timers**.



Figure 3-20: Timer Setup screen

- **Open State Time.** Value indicates how long each gate will remain open allowing grain to flow through.
- **Clear Delay.** When the level of the grain is no longer high enough to trigger the Open Level and Close Level settings, the Clear Delay starts. When the Clear Delay timer expires, the system can process a end-of-cycle sequence.
- **Weigh time.** The amount of time data is collected and averaged to determine the actual weight reading

Actuators

The Actuator Setup screen is used to select the appropriate type of actuator and transition times for your system. To access the screen, choose **Setup** (F3) on the main FRS screen. Then select **Hardware Setup > Classic Graingage Setup > Actuators**.



Figure 3-21: Select Actuators from the Setup menu to access the Actuator Setup screen

Once you see the Actuator Setup screen, select the appropriate actuator type from the drop-down menu for each actuator.

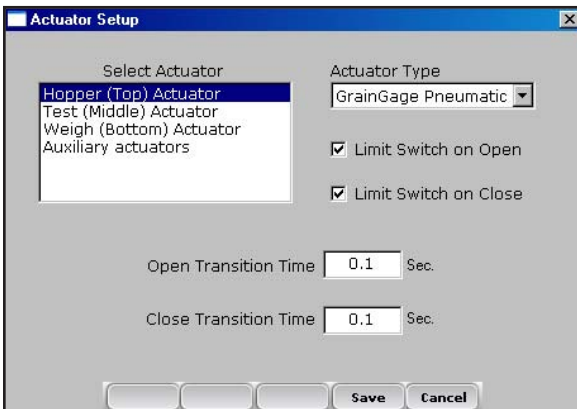

Figure 3-22: Actuator Setup screen

If limit switches are being used (limit switches are used by default and are recommended), check the boxes accordingly. If limit switches are not being used, enter the time in seconds needed for the stroke of the actuator to fully extend or retract. In the example above, the limit switch is enabled for the Hopper (top) on the closing transition only. On the opening transition, a time of 0.8 seconds controls the actuator.

Setup File

The **Setup File** option on the Setup menu is a way to establish specific settings for a specific machine. This is helpful if you want to use your handheld with more than one combine. The steps below explain how to establish setup files for two combines.

1. Set up and calibrate one combine.
2. Enter the Setup File screen by selecting **Setup File** in the Setup menu. A list of existing setup files appears.



Figure 3-23: Setup files that appear by default

By default, the settings you created when you set up and calibrated the handheld were saved to the Default setup file.

3. To create a setup file for a second combine, click **Save** (F4).
4. Create a name for the second setup file.

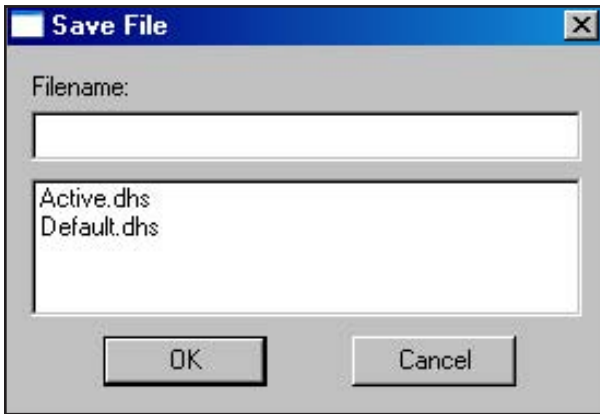

Figure 3-24: Naming a new setup file

5. Repeat steps 1–2. The new setup file appears.



Figure 3-25: The new setup file appears

As you can see in the first column, this second setup file is now the active file, which means that any setting and calibrations changes you make are automatically saved to that file. To make another setup file active, select it then click **Select**.

To create setup files for additional machines, repeat the process.

CHAPTER 4

DIAGNOSTICS MENU

Load Cell

Moisture

Level Detect Sensor

Actuators

Print Calibrations

Diagnostics Menu

The Diagnostics menu is designed to help you troubleshoot and test your hardware. To access this option, select **Diag.** (F4) from the main FRS screen. Six submenu options appear on the Diagnostics Menu page shown in the following image. Each option is described below.

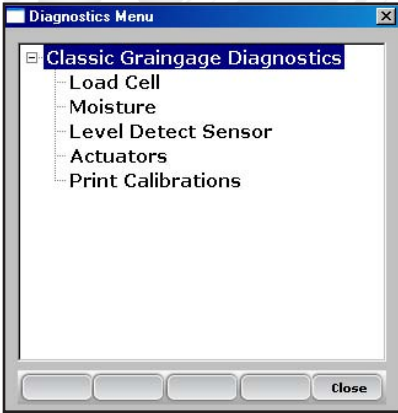

Figure 4-1: Diagnostics Menu screen

Load Cell

Checking the calibration

You can check the calibration of the load cell using the options on the Diagnostics Menu screen. Before you do that, however, first check the accuracy of your calibrations by ensuring that

- the combine is on level ground and out of the wind
- the weigh bucket is empty
- the calibration weight is close to 5 lbs or 2.23 kg

Follow these steps to check your load cell calibration:

1. From the Diagnostics Menu, select **Load Cell**. The Diagnostics Load Cell screen appears, shown here.

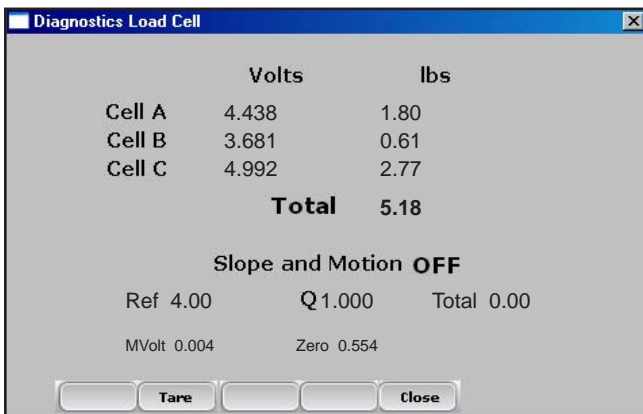
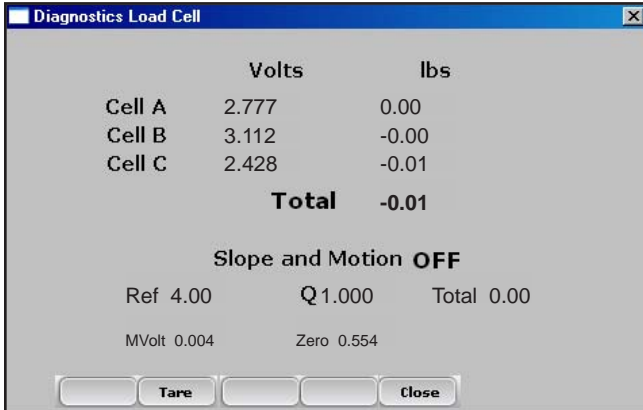

Figure 4-2: Diagnostics Load Cell screen

2. Make sure the weight values for Cell A, Cell B, Cell C and the total weight all equal close to zero. If not, tare the system by selecting **Tare** (F2).



| | Volts | lbs |
|-----------------------------|------------|--------------|
| Cell A | 2.777 | 0.00 |
| Cell B | 3.112 | -0.00 |
| Cell C | 2.428 | -0.01 |
| Total | | -0.01 |
| Slope and Motion OFF | | |
| Ref 4.00 | Q 1.000 | Total 0.00 |
| MVolt 0.004 | Zero 0.554 | |

Buttons: Tare, Close

Figure 4-3: Weight values for Cell A, Cell B, Cell C and Total change after a tare

3. Place your known weight onto weigh pan.
4. The weight shown in the Total line should match your known weight. If the weight is incorrect, recalibrate the load cells by returning to the main FRS page and selecting **Setup > Hardware Setup > Classic Graingage Setup > Weight Calibration**.

In addition to showing information related to the load cells, the Diagnostics Load Cell screen shows the values associated with the Slope and Motion Sensor. Information for this screen is described on the following page.

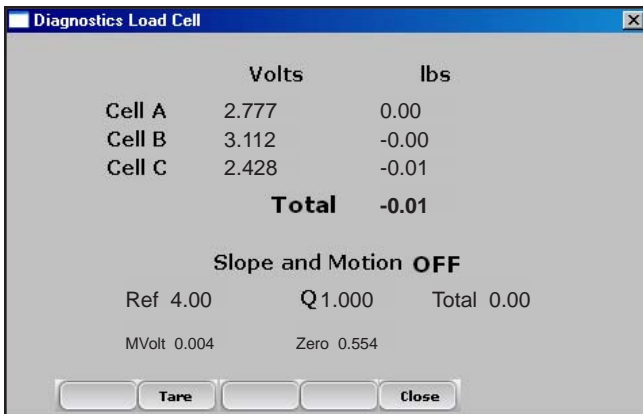

Figure 4-4: Elements of the Diagnostics Load Cell screen

Volts (voltage)

The Volts reading displays the raw voltage reading from load cells A, B and C.

Lbs or kg (weight)

The weight reading displays the calibrated weights of the load cells.

Total

This value reflects the total weight on all load cells plus any adjustment if the Slope and Motion sensor was turned on.

Ref, Q, and Total

These values are used for calculations. Note that the Q value should typically read 1.000. If it does not, we recommend that you disable then re-enable the Slope and Motion sensor from the Setup menu.

Slope and Motion status

The SM status shows whether the Slope and Motion Sensor is turned **On** or **Off**.

Tare (F2)

Retares the load cells if the Total weight is not zero.

Moisture

The Moisture option allows you to view readings associated with the EM Grain Moisture sensor.

To view the Diagnostics Moisture screen, select **Moisture** from the Diagnostics menu. The following information is displayed.

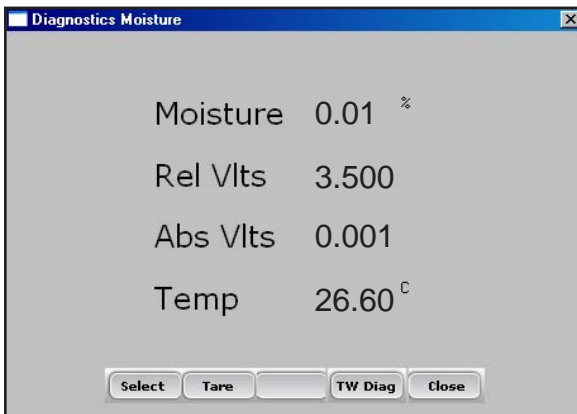

Figure 4-5: Diagnostics Moisture screen

Moisture

The percentage of moisture read by the moisture sensor.

Rel Vlts (Relative Volts)

The tared-out voltage reading of the moisture sensor.

Abs Vlt (*Absolute Volts*)

The raw voltage reading from the moisture sensor.

Temp (*Temperature*)

The temperature read from the moisture sensor.

Tare (*F2*)

To retare the moisture reading, select **Tare** (F2).

Select (*F1*)

Clicking **Select** opens the moisture curve menu screen, allowing you to select a moisture curve to be used for checking calibration. Select the curve and click **Select** (F1) again to return to the previous screen.

LED Codes on the EM Grain Moisture Sensor

Green, yellow, and red LED's (light emitting diode) are designed into the sensor for service and diagnostics purposes. These LED's can be viewed by looking at the right side of the white plastic housing of the sensor. The function of the LED's are described as follows.

Green: On solid when +12 VDC is applied to the sensor

Yellow: Blinks whenever a message is transmitted from the sensor such as when the application software is in the moisture diagnostics menu.

Red: Indicates sensor error conditions. With no error codes, the red alternates one second on, then one second off.

Chapter 4

Any error codes are represented by pairs of 'rapid blinking', the number of blinks corresponding to the first and second digit of an error code from the list below:

11. Watchdog reset has occurred
12. Timed Task Buffer overflow detected
13. Low memory alert ($M < 50$ bytes)
21. Input buffer overrun
22. Checksum error detected
23. Unrecognized command received by sensor
24. RS-485 busy encountered
25. Sensor response message aborted
32. Frequency measurement zero error (no oscillation counts)
33. Frequency measurement range error (over 3 Mhz)
41. Blade voltage range error
42. Temperature sensor zero error (reading at or below -15° C (5° F))
43. Temperature sensor range error (reading above $+60^{\circ}$ C)
44. System supply voltage below +10.0 Volts
45. System voltage above +18.0 Volts
55. Invalid error code reported

When the sensor is operating normally, no error codes should show. There should just be a steady one second on, one second off blink of the red. Otherwise, general interpretation would be:

- 11, 12, 13, 55: Software system problems. Report to customer service and design engineering with description of circumstances.
- 21, 22, 23, 24, 25: Faulty sensor wires, or faulty SCCU. These could be caused by some fault within the EMGS, but it is not likely.
- 32, 33, 41: Likely cause would be a bad connection from the sensor to the ground plane around the blade, or from the sensor board to the blade.
- 42, 43: Assuming the temperature is in a normal ambient range from -10 C to +40 C, these codes would indicate a failed temperature sensor, or board solder connection.
- 44,45: These are more likely caused by a problem in the power supplied to the EMGS.

Level Detect Sensor

The Diagnostics Level Detect Sensor screen shows readings from the level detect sensor, which is used to detect the level of grain in a bucket. To access this screen, select **Diag** (F4) from the main FRS screen, then select **Level Detect Sensor**. The following information is displayed.



Figure 4-7: Diagnostics Level Detect screen

Current

The current readings from the level detect sensor.

Tare Value

The zero reference frequency

Trip Point

The minimum reading that the level detect must reach before cycling the system.

Tare (F2)

Retares the level detect reference frequency.

Actuators

This Actuator Controls screen allows you to open, close, or cycle any or all of the actuators. To access this screen, select Diag. (F4) from the main FRS screen, then select **Actuator**. The Actuator Controls screen appears.

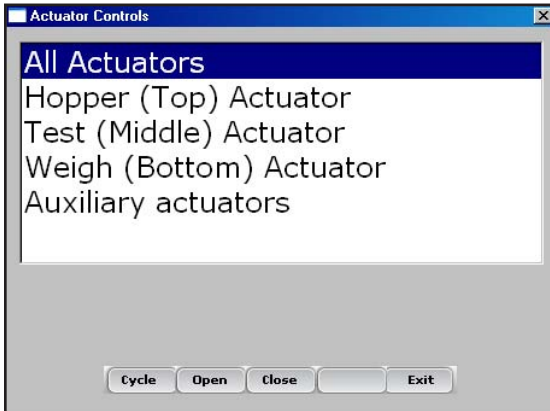

Figure 4-8: Actuator Controls screen

Select the actuator you want to control, and choose from one of the menu options: **Cycle** (F1), **Open** (F2), or **Close** (F3).

Print Calibrations

The Print Calibrations menu allows you to print your calibration settings. To print, simply select one of the calibration options and click **Print** (F1).

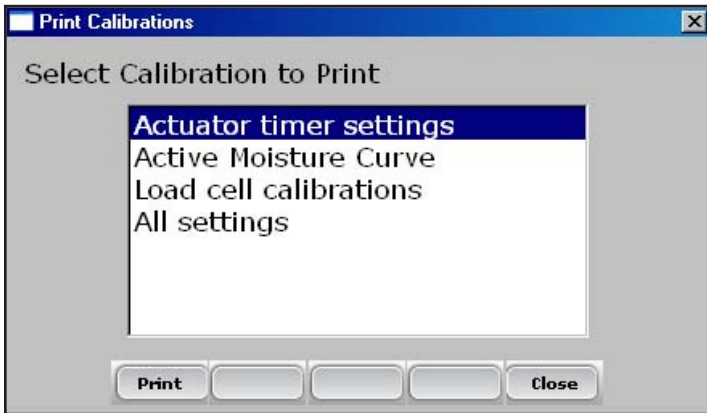
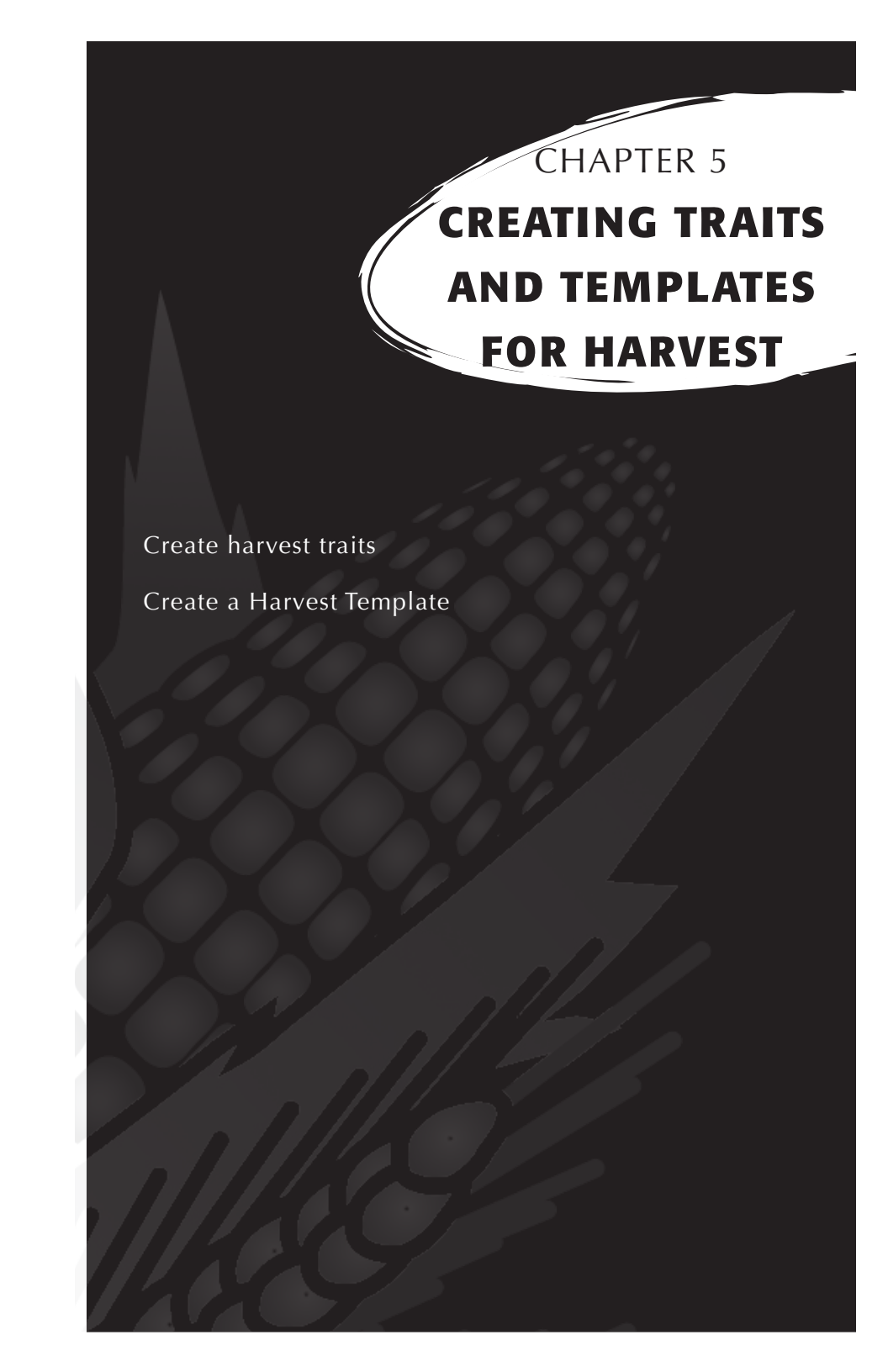

Figure 4-9: Print Calibrations screen



CHAPTER 5
**CREATING TRAITS
AND TEMPLATES
FOR HARVEST**

Create harvest traits

Create a Harvest Template

Creating Traits and Templates for Harvest

Create harvest traits

Before you can collect harvest data, you first need to add or select harvest traits from the Master Traits List and create a harvest trait template for these new traits. FRS includes sample harvest traits and templates. You can create your own traits or modify the traits that are included with FRS.

Note: It is especially important that traits that reflect data from the GrainGage, such as moisture and weight, are set up correctly in order for the software to register data from the hardware. If these traits are not set up correctly, data will not be recorded from these devices.

Adding a trait to the Master Traits List

Follow these steps to add a trait to the Master Trait List:

1. Open the Master Traits List screen by choosing **Setup** (F3) and clicking **Traits Management**.

2. Select **Add** (F1) from the Master Traits List screen.

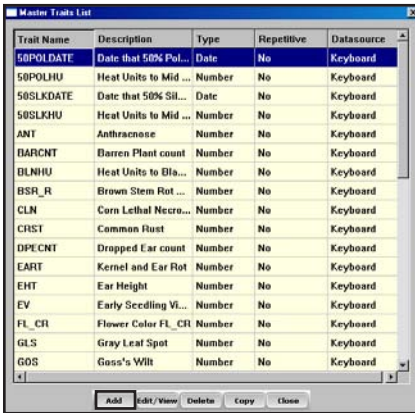

| Trait Name | Description | Type | Repetitive | Datasource |
|------------|-----------------------|--------|------------|------------|
| 50POLDATE | Date that 50% Pol... | Date | No | Keyboard |
| 50POLHU | Heat Units to Mid ... | Number | No | Keyboard |
| 50SLKDATE | Date that 50% Sil... | Date | No | Keyboard |
| 50SLKHU | Heat Units to Mid ... | Number | No | Keyboard |
| ANT | Anthraxnose | Number | No | Keyboard |
| BARCNT | Barren Plant count | Number | No | Keyboard |
| BLNHU | Heat Units to Ela... | Number | No | Keyboard |
| BSR_R | Brown Stem Rot ... | Number | No | Keyboard |
| CLN | Corn Lethal Necro... | Number | No | Keyboard |
| CRST | Common Rust | Number | No | Keyboard |
| DPECNT | Dropped Ear count | Number | No | Keyboard |
| EART | Kernel and Ear Rot | Number | No | Keyboard |
| EHT | Ear Height | Number | No | Keyboard |
| EV | Early Scudding Vl... | Number | No | Keyboard |
| FL_CR | Flower Color FL_CR | Number | No | Keyboard |
| GLS | Gray Leaf Spot | Number | No | Keyboard |
| GOS | Goss's Wilt | Number | No | Keyboard |

Buttons: Add, Edit/View, Delete, Copy, Close

Figure 5-1: Create a new trait list by selecting Add on the Master Traits List screen

3. Type in a name you would like to use for harvest traits. Common names used are **Moisture** for grain moisture, **Weight** for plot weight, and **Test** for the grain test weight.

Important: If you are collecting harvest data, you need to create a trait for weight. Creating traits for moisture and test weight is optional.

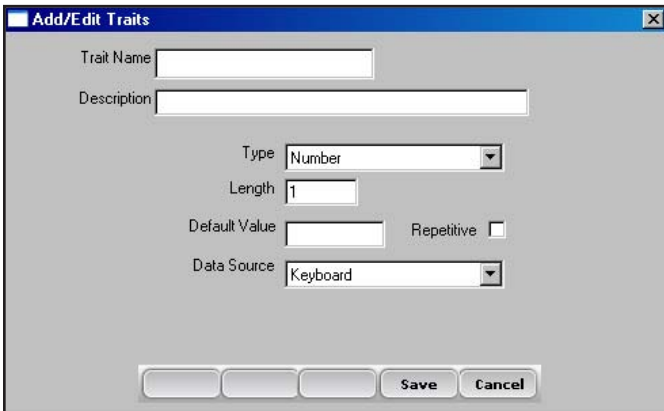

Trait Name:
 Description:
 Type:
 Length:
 Default Value: Repetitive:
 Data Source:
 Buttons: Save, Cancel

Figure 5-2: Entering a Trait Name for a new trait

4. Skip down to Data Source on the screen and select ***HM-Moisture, HM-Weight, or HM-Test Weight*** from the drop-down box depending on which trait you are creating. In order for the trait data to be recorded from the GrainGage, the correct data source must be selected. The Type and Length information is automatic.

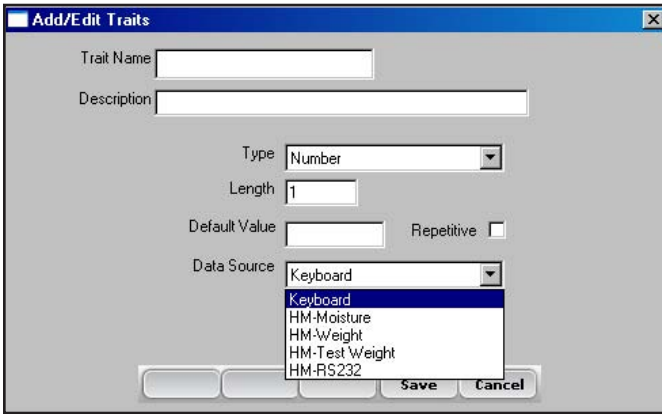

Figure 5-3: Selecting a Data Source

5. **(Optional)** Add a trait description to clarify the type of trait that has been created. Example: ***Moisture of grain at harvest.***

6. Save the new trait by clicking Save (F4).

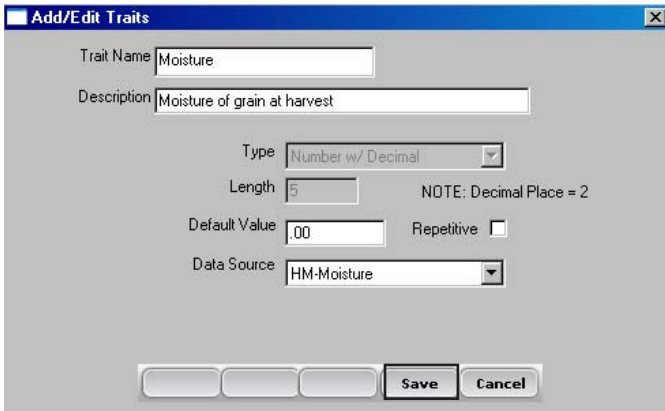

Figure 5-4: Saving a new harvest trait

Create a Harvest Template

After you have added harvest traits to the Master Trait List, create a trait template that contains these new traits.

Chapter 5

To create a trait template, follow these steps:

1. From the Setup Menu, expand the Traits Management option and selecting *Trait Templates*.

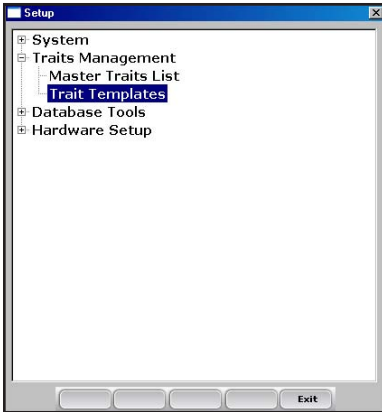

Figure 5-5: Select Trait Templates to open the Trait Templates screen

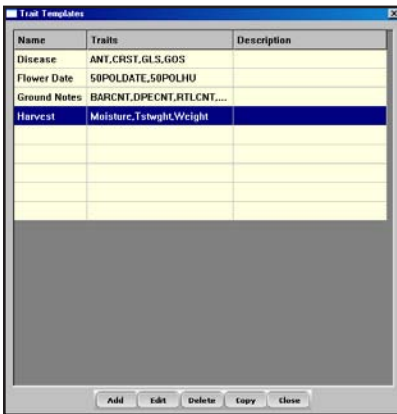

Figure 5-6: Trait Templates screen

2. Select **Add** (F1) to create a blank template. The Add/Edit Trait Templates screen appears.

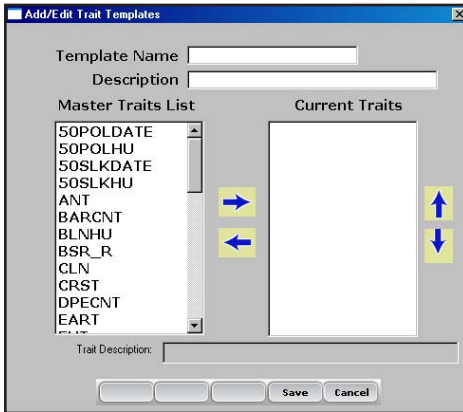

Figure 5-7: Add/Edit Trait Templates screen

3. Type a Template Name and Description to help identify the template. (**Harvest or Harvest Data are suggested template names.**)
4. Scroll down through the Master Traits List to find the Weight, Moisture and Test Weight traits you created. Highlight one of the traits, then click on the Right Arrow in the middle of the screen to move it to the Current Traits window. In the example below, Weight, Moisture, and Test traits have been added as Current Traits.

Note: You can change the trait order by clicking the up or down arrows on the screen.

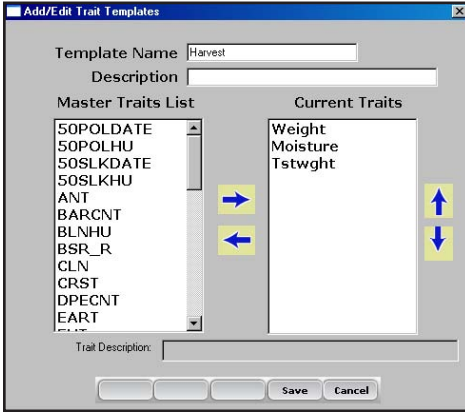

Figure 5-8: New template called Harvest

5. Click **Save** (F4) to save the new template.



CHAPTER 6
**HARVEST DATA
COLLECTION**

Preparing to collect harvest data

Harvesting and collecting data

Harvest Data Collection

After you have calibrated the Classic GrainGage, created harvest traits, and created a new harvest trait template, you are now ready to collect data. This chapter explains how to prepare for, collect, and view harvest data using FRS. For additional information, refer to the *FRS Field Reference Guide (Note Taking)*.

Collection Screen

FRS Laptop has a distinct advantage in that the collect screen allows users a view of several different screens at the same time. It is divided into four areas: Control Panel, Form Screen, Spatial View and List View.

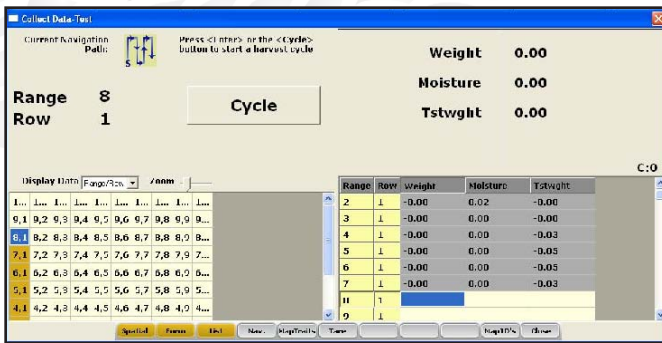

Figure 6-1: Collection Screen

Control Panel

This portion of the screen shows the navigation path, the current plot and the Cycle button.

Form Screen

This shows the data as it is collected as well as live readings of the weight and moisture.

Spatial View

Several options are available from the Spatial View. The pull-down menu offers a look at the RangeRow layout of the map or weight, moisture, or test weight of any plots that have been collected. This view is helpful to assure desired navigation of the field/map or to re-position to any plot on the map.

NOTE: When re-positioning, select the desired plot location, then go to the navigation screen to save that new setting before continuing the collection activity.

List View

The List View allows you to see your harvest data after it is collected.

Preparing to collect harvest data

Follow these steps to prepare FRS to collect harvest data:

1. On the FRS Main Screen, make sure the Active Devices at the bottom of the screen shows HM800 Classic GrainGage.

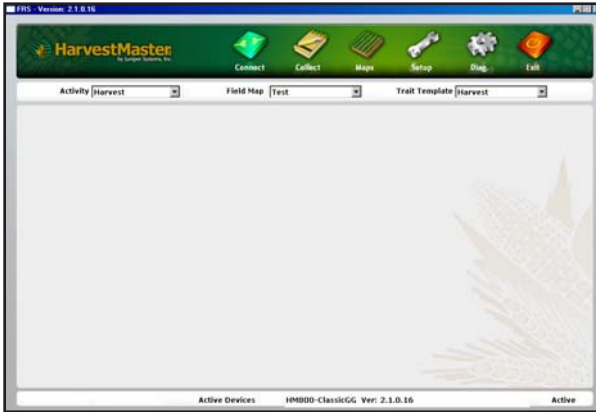

Figure 6-2: *The HM800-Classic appears as the Active Devices at the bottom of the screen.*

2. Select the appropriate activity from the Activity drop-down menu on the FRS Main Screen. For example, if you plan to use FRS for harvesting, select the **Harvest** activity. For standard plot lengths, set the activity to Harvest-Plot.
3. On this same screen, select the correct field map name from the pull down menu.

Note: If you need a new field map for harvest, create one before proceeding to the next step. Refer to the FRS Note Taking Field Reference Guide (Note Taking) manual for instructions on creating a new field map.

4. Select the trait template you want to use from the Trait Template drop-down box. Options include the harvest traits you created such as Weight, Moisture or Test Weight.
5. Select **Collect** (F1) to enter data collection mode. The Moisture Calibration screen appears.

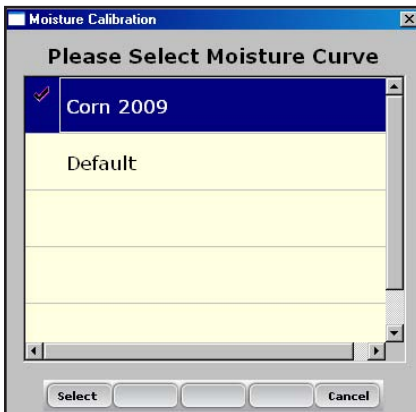

Figure 6-3: Moisture Calibration screen

6. Select a moisture curve from the list, then click **Select** (F1). Wait while harvest set ups are loaded.

7. The Collect Data Spatial screen appears, shown below.

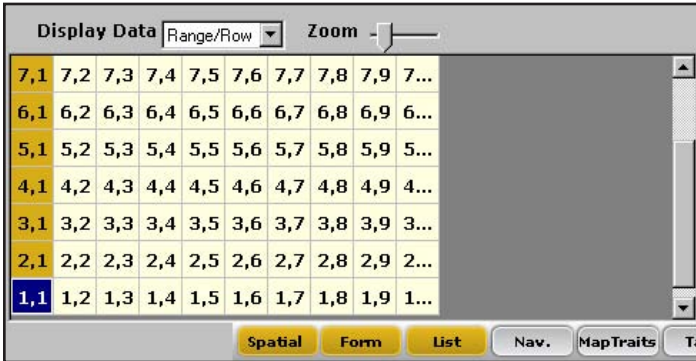

Figure 6-4: Row 1, Range 1 is selected in the Collect Data Spatial space of the screen

- 8. Choose the starting plot location by clicking on the cell. In Figure 6-4, the selected cell is Row 1, Range 1. After you click on the starting plot cell, the screen shows the combine's current location in the field and which plots have already been harvested.
- 9. Establish your navigation type by selecting **Nav.** (F4). The Select Navigation screen appears.

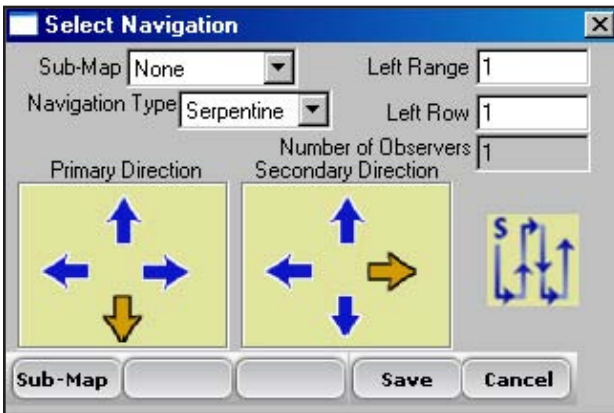

Figure 6-5: Select Navigation screen for a single plot combine

Navigation Type

The navigation type is the harvest route through a field.

Select a navigation type from the pull down menu. Examples of Navigation patterns for harvest are shown below.

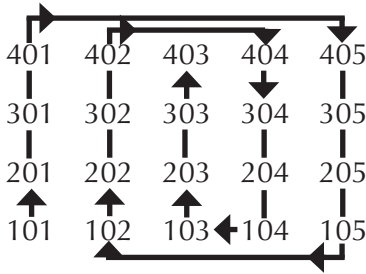

Figure 6-6: Circular navigation type

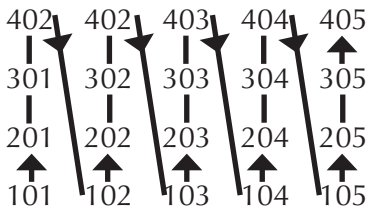

Figure 6-7: Sequential navigation type

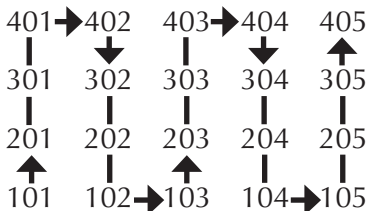

Figure 6-8: Serpentine navigation type

Click **Save** (F4) to save your settings.

Harvest Sequence

The Classic GrainGage is an all-inclusive system with a hopper chamber, test chamber, and plot chamber. These chambers are stacked on top of one another inside of the GrainGage. A slide gate or door separates the chambers. Unlike bucket systems that measure all of the grain in a plot at once, the graingage processes the grain in batches or incrementally.

Plot Harvest

1. The user drives the combine through the 20-ft plot. Grain is shelled in the combine and routed into the holding hopper. At the end of the plot, the user stops the combine allowing it to clean out. The Classic GrainGage begins processing the grain as it reaches the holding hopper.
2. When grain level inside of the hopper reaches a point high enough to trigger the Open Level, the Classic GrainGage begins to cycle.
3. The Hopper door opens. Grain drops into the Test Chamber filling it up until it reaches a point on the Level Detect to trigger the Close Level, which causes the Hopper door to close.
4. With the Hopper door closed, the Moisture readings are taken by the EM Sensor. The Test Chamber should be full in order to get accurate Moisture and Test Weight readings.

5. After Moisture has been recorded, the Test Chamber door opens dropping the grain into the Plot chamber. The Test Chamber closes initiating the weight cycle.
6. The grain weight is measured in the Weigh or Plot chamber. After this reading has been taken, the Plot door opens dumping out the grain out of the GrainGage.
7. At this point, the weight and average moisture are displayed on the screen of the FRS software along with cycle count.
8. This process continues as long as grain is high enough in the Hopper Chamber to trigger the Level Detect. The system does not have to wait for the Plot finish before the Hopper door opens to dump the next amount of grain in the Test Chamber. As soon as the Test Chamber door has closed indicating its contents have been emptied, the Hopper door can open.

| | |
|-----------------|-------------|
| Weight | 0.00 |
| Moisture | 0.00 |
| Tstwght | 0.00 |
| | C:0 |

Figure 6-9: Classic GrainGage cycling

Chapter 6

9. If the grain fails to trigger the Level Detect, the system stops cycling on its own. The user will then press the Enter key to initiate two complete cycles of the system to clean out the remaining grain. No moisture or test weight is recorded during these last two cycles, only plot weight.

Note: If the user presses the Enter key at any time while the GrainGage is processing grain, the Enter key is registered but the GrainGage continues to cycle. The Enter key is processed as soon as the grain level no longer triggers the level detect.

10. After the second clean-out cycle, the total Weight, Average Moisture, and Average Test Weight for the entire plot is stored into the FRS database and sent to the printer. Backup data is also stored in log files and data are displayed on the screen. The last chamber weight is also shown on the display at bottom of the screen.

| | |
|-----------------|--------------|
| Weight | 2.33 |
| Moisture | 9.34 |
| Tstwght | 59.04 |
| | C:1 |

Figure 6-10: Total plot info

11. The user can drive into the next plot as soon as the Enter key is pressed or after data is sent to the printer whichever is preferred by the driver.



CHAPTER 7
DATALINK FOR FRS

Import files to database from desktop

Export files from database to desktop

DataLink Utilities

DataLink for FRS

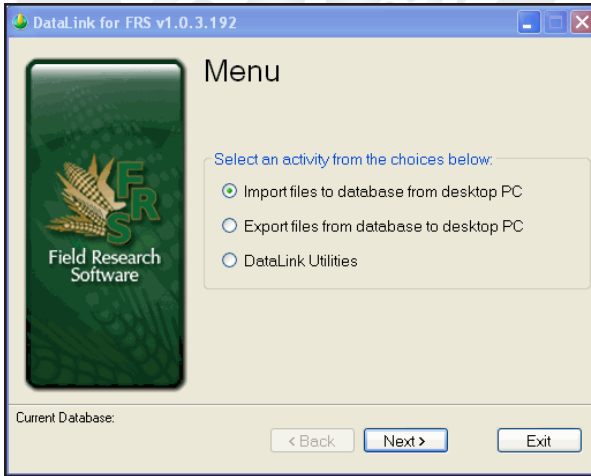

Figure 7-1: DataLink main menu

DataLink for FRS is a utility program for your PC that facilitates the management of the FRS database.

DataLink Functions

Three functions are available from the opening screen for *DataLink for FRS*.

The three functions are:

- Import file to database from desktop PC
- Export files from database to desktop PC
- DataLink Utilities

DataLink is found under *Setup* and *Database Tools*.

Importing a File to the Database

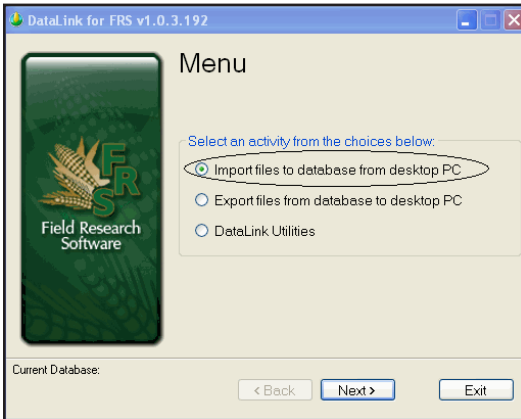

Figure 7-2: Importing file to database

Select the **Import** option and click **Next**.

Several types of files can be imported to the database.

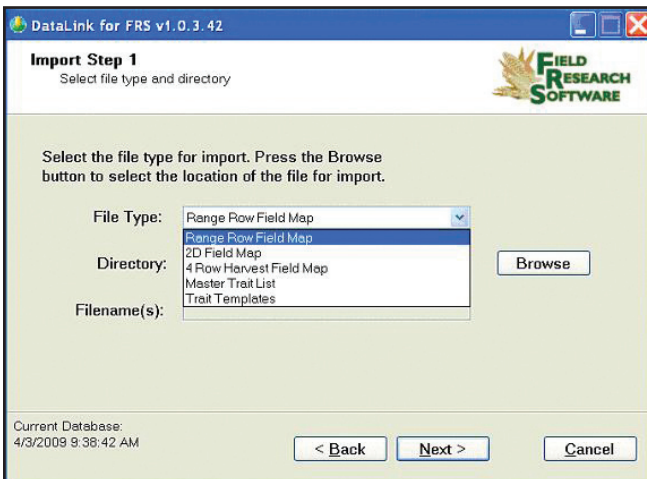

Figure 7-3: Select file type

Chapter 7

- Range Row maps are the most common field maps in FRS.
- 2D and 4 Row maps are specialty maps for specific applications.
- The Master Trait List is a list of all traits that can be observed.
- A trait template is for organizing a smaller list of traits that are of interest for daily or seasonal observations.

These files can be created or edited on a PC and then imported to the FRS database using **DataLink**.

As is common in many Windows applications, the browse feature lets you select the file to import.

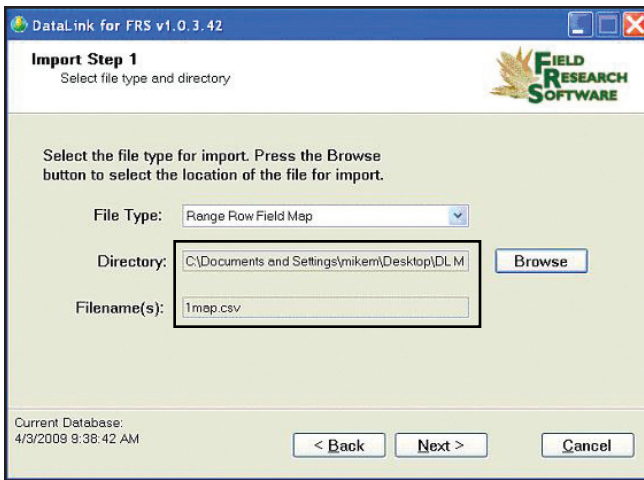

Figure 7-4: Select file

When a field map is selected, the **Next** button allows you to choose map settings. FRS organizes all maps by range row, and then handles any other map identifiers simply as additional identifiers. Therefore range row must be defined as to its location in the spreadsheet that is being imported.

DataLink reads the column headings from the map to be imported, and populates them in the drop down menu. Select the appropriate column heading from the map that corresponds to the Range and Row from the choices in the drop down menu.

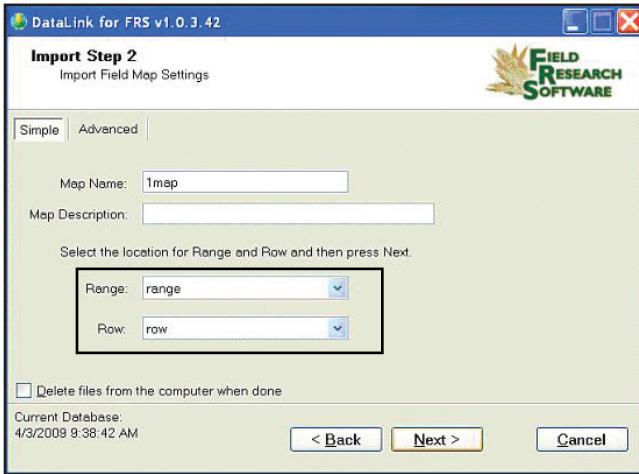

Figure 7-5: Range and Row headings

The following discussion involves specialty maps that may or may not apply to your situation. If you do not need to use 2D maps or 4 Row Harvest maps, skip this section.

The 2D Map feature refers to maps that are created two-dimensionally to represent the same layout as the field.

ID's in 2D maps allows any plot name in any order to be used on a map. Plot names can be repeated on the same map as many times as needed. This type map must be created with a spreadsheet or text editor and saved as a tab delimited file or .txt file. Do not use any headings or spaces when creating a 2D map.

| | | | |
|-------|--------|--------|---------|
| 101 | Trial | Border | 102 |
| 201 | 202 | North | South |
| 101 | 102 | 103 | 104 |
| 201 | 202 | 203 | 204 |
| Beans | Rice | Wheat | Corn |
| Sally | George | Sue | Charles |

Figure 7-6: Example of 2D map layout

DataLink will assign range row to each plot and associate the plot IDs as additional plot identifiers.

The 4 Row Harvest Field Map is a unique layout where every other plot or set of 2 rows is border throughout the field. 4 Row Harvest Field Maps allow a map that only contains the research rows to be imported into FRS. Upon import, the border rows are created by FRS and carry the same row number as the previous research row with the addition of an "X."

Example is the first row or plot is Range 1 Row 1, then next row or plot is designated Range 1 Row 1X. This sequence is repeated throughout the field.

The field is harvested the same as any other field map with data being stored for research plots and buffer plots. Upon Export, the buffered rows are not exported, only the research rows are included in the export file.

Importing Master Trait Lists and Templates

Master trait lists and trait templates are files that can be imported. When you import either, the existing list or

templates will be deleted. A warning appears so the user can confirm the action.

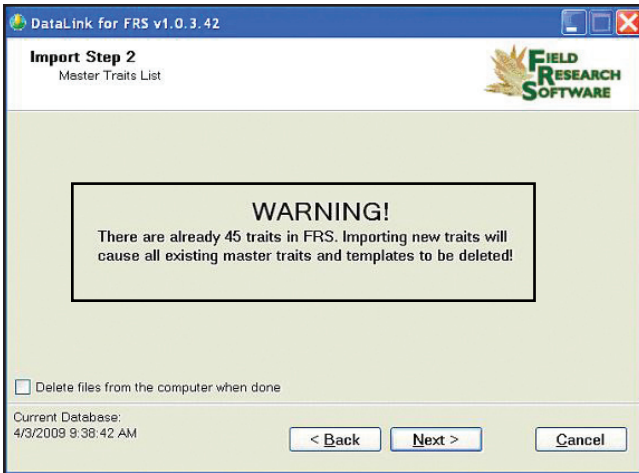

Figure 7-7: Warning on importing traits

Exporting a File from the Database

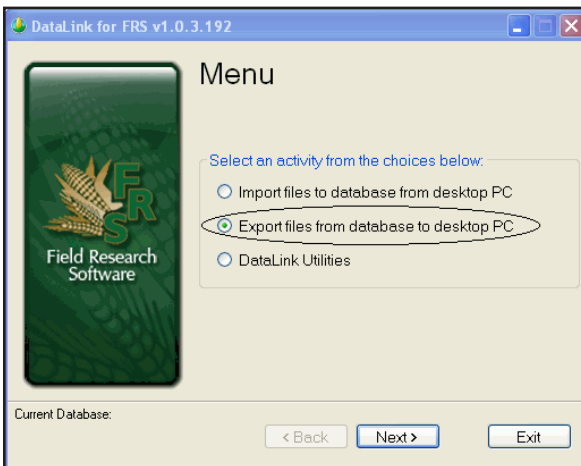

Figure 7-8: Export files from database

Select the *Export* option and click *Next*.

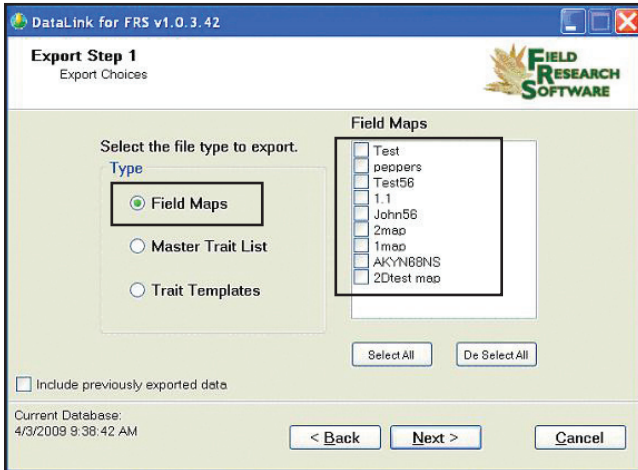

Figure 7-9: File types and files

This screen allows the selection of what file type and which files to export. The ***include previously exported data*** checkbox allows data collected and exported in separate activities or days to all be exported together on one spreadsheet at the conclusion of a map.

For example, at the end of the season, a spreadsheet could contain several observations accomplished with different templates and traits and the harvested data together on one map.

Imagine that in the spring, an emergence observation could occur and the data down-loaded for safe keeping. Mid summer might be a good time to take notes on any disease evidence and that data could be downloaded. In the fall a lodging study might be appropriate and downloaded after completion. Then the crop is harvested and the plot weight, moisture and test weight are recorded. When this last data is

exported the “Include previously exported data” checkbox could be checked. The spreadsheet would now contain all the collected data from the season in one place.

After making the desired selection and selecting next, the choice is where to put the exported files. The browse button facilitates the choice.

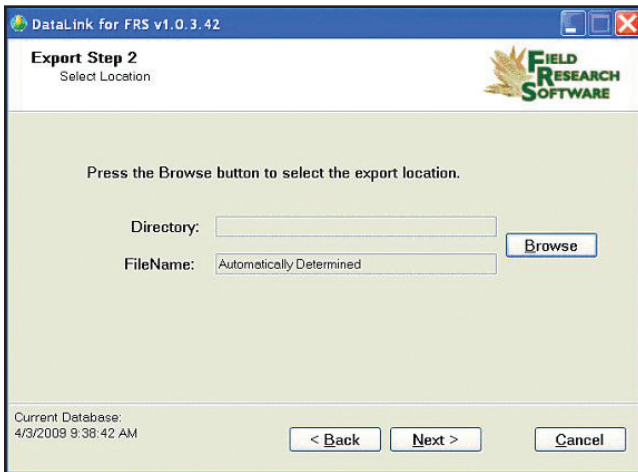

Figure 7-10: Exported file location

Step 3 allows the user to choose the map IDs and in what order, they will appear in the exported file.

Notice the checkbox near the bottom of the screen. If a map was imported as a 4 Row Harvest Field Map and buffer rows

Chapter 7

were added, checking this box will remove those added rows when the file is exported.

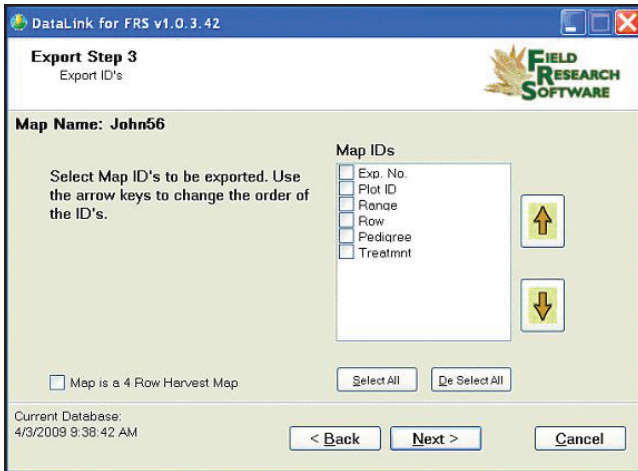

Figure 7-11: Choose which row to export

DataLink Utilities

Select *DataLink Utilities* and click *Next*.

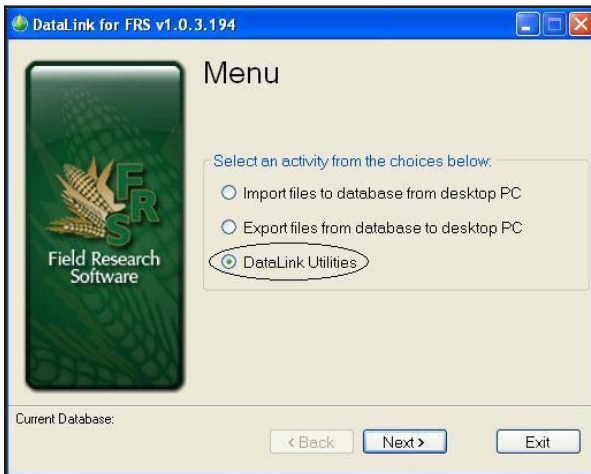

Figure 7-12: Datalink Utilities

The utility choice available is Clean Current Database.



Figure 7-13: Utility choice

This produces a compressed database that only contains active records, removing records that are marked as deleted and rebuilds all indices creating new optimized indices in the database. Selecting this periodically will help resolve any database issues and increase performance.

Select the *Clean Current Database* option and click *Next*.

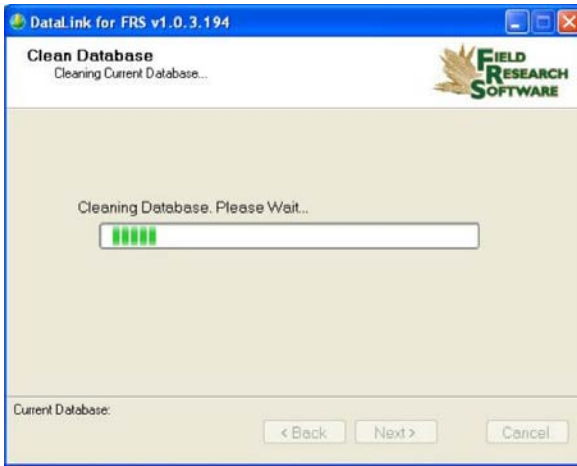

Figure 7-14: Cleaning Database screen

Notice that time was spent cleaning up the database. The time this requires is proportional to the size and length of time the database has been used.

Backup Log for Harvest Modules

FRS software creates a backup log of data that has been collected from the harvester. This log file contains the date, time, range, row, plot weight, moisture, and test weight for each plot harvested. It also contains values used for moisture and test weight calibration, and Slope and Motion compensation, or Q value.

The backup files can be found in the FRS folder in the backup folder.

Each backup log references the same name as the field map

used for harvest. For example, if the name of the field being harvested is Smith Farm, the name of the backup log would be Smith Farm_Classic.csv.

| | A | B | C | D | E | F | G | H | I | J | K |
|----|------------|----------|-------------|-----------|-----|--------|--------|----------|-------------|----------------|---------------|
| 1 | Date | Time | Range (ID1) | Row (ID2) | ID3 | Cycle# | Weight | Moisture | Test Weight | Slope Motion Q | Uncomp Weight |
| 2 | 18/02/2008 | 14:50:54 | 1 | 1 | | 0 | 0 | 0 | 0 | 0.000 | 2.441 |
| 3 | 18/02/2008 | 14:51:34 | 1 | 1 | | 1 | 2.312 | 9.275 | 58.499 | 1.000 | 0 |
| 4 | 18/02/2008 | 14:51:40 | 1 | 1 | | 2 | 2.289 | 9.111 | 57.907 | 1.000 | 2.312 |
| 5 | 18/02/2008 | 14:51:45 | 1 | 1 | | 3 | 0.936 | 5.749 | 23.686 | 1.000 | 2.289 |
| 6 | 18/02/2008 | 14:52:08 | 1 | 1 | | 4 | -0.003 | 0 | -0.063 | 1.000 | 0.936 |
| 7 | 18/02/2008 | 14:52:14 | 1 | 1 | | 5 | -0.003 | 1.003 | -0.086 | 1.000 | -0.003 |
| 8 | 18/02/2008 | 14:52:16 | 1 | 1 | T | | 5.532 | 8.045 | 46.697 | | |
| 9 | 18/02/2008 | 14:53:29 | 2 | 1 | | 1 | 2.307 | 9.148 | 58.358 | 1.000 | 0 |
| 10 | 18/02/2008 | 14:53:35 | 2 | 1 | | 2 | 2.303 | 9.271 | 58.262 | 1.000 | 2.307 |
| 11 | 18/02/2008 | 14:53:40 | 2 | 1 | | 3 | 0.939 | 5.829 | 23.788 | 1.000 | 2.303 |
| 12 | 18/02/2008 | 14:54:06 | 2 | 1 | | 4 | 2.303 | 9.312 | 58.264 | 1.000 | 0.939 |
| 13 | 18/02/2008 | 14:54:12 | 2 | 1 | | 5 | 0.803 | 5.165 | 20.318 | 1.000 | 2.303 |
| 14 | 18/02/2008 | 14:54:31 | 2 | 1 | | 6 | 0.002 | 0 | 0.04 | 1.000 | 0.803 |
| 15 | 18/02/2008 | 14:54:36 | 2 | 1 | | 7 | 0.002 | 0 | 0.058 | 1.000 | 0.002 |
| 16 | 18/02/2008 | 14:54:39 | 2 | 1 | T | | 8.659 | 7.745 | 43.794 | | |
| 17 | 18/02/2008 | 14:55:26 | 3 | 1 | | 1 | 2.334 | 9.344 | 59.036 | 1.001 | 0.002 |
| 18 | 18/02/2008 | 14:55:31 | 3 | 1 | | 2 | 2.286 | 9.287 | 57.839 | 1.000 | 2.334 |
| 19 | 18/02/2008 | 14:55:37 | 3 | 1 | | 3 | 0.926 | 5.834 | 23.427 | 1.000 | 2.286 |

Figure 7-15: Example of backup log file.

Chapter 7

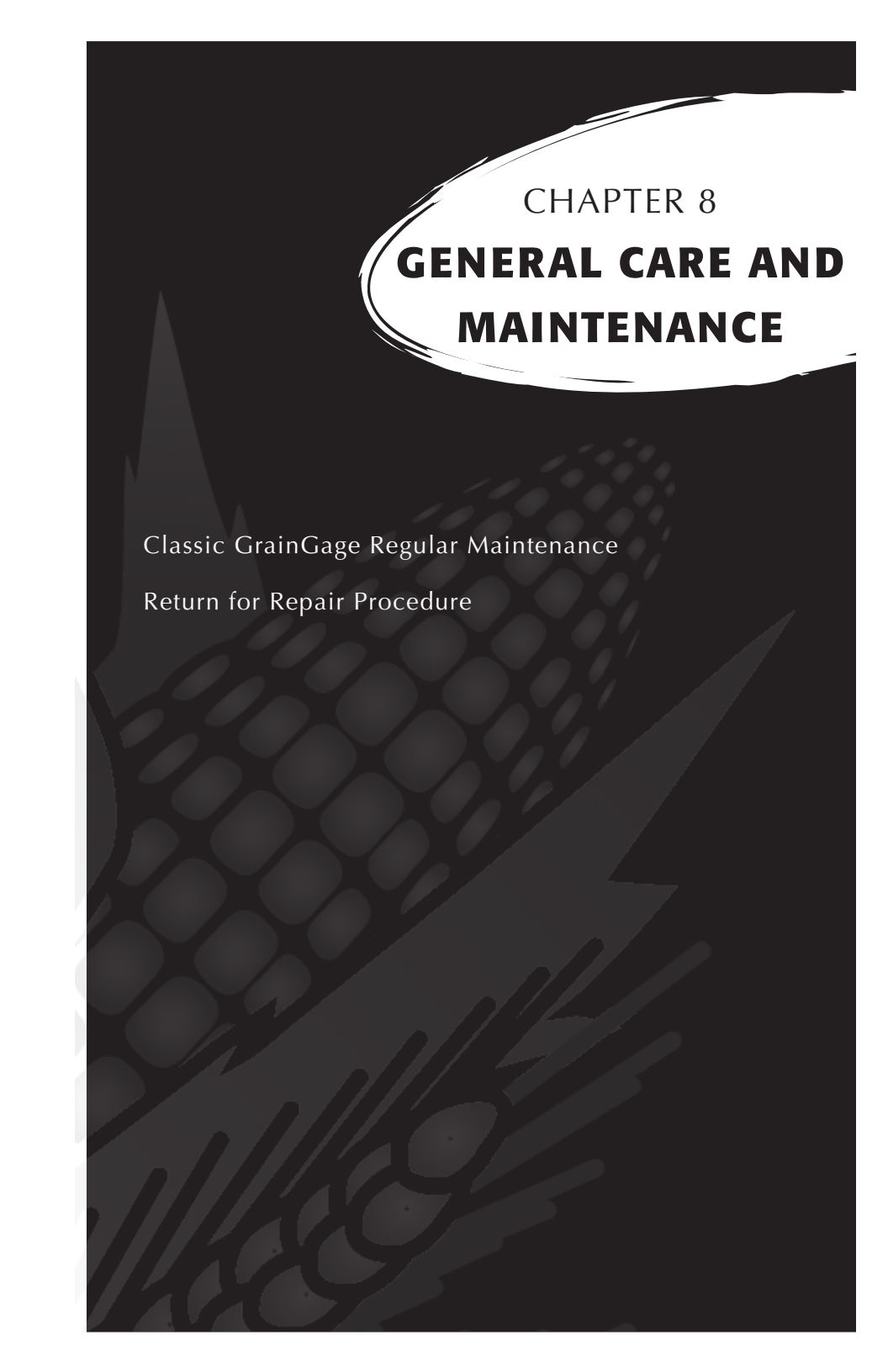

CHAPTER 8
**GENERAL CARE AND
MAINTENANCE**

Classic GrainGage Regular Maintenance
Return for Repair Procedure

General Care and Maintenance

Classic GrainGage Regular Maintenance

HarvestMaster products are built to be robust and will withstand most weather conditions. All of our products are environmentally sealed and built for outdoor use. However, there are some steps you can take that will increase the operational life of the system. The following tips will help you to have fewer problems and will ensure the maximum life out of your system.

Recommended Pre-Harvest Maintenance

We recommend starting your pre-harvest checklist at least two weeks before you plan to be in the field. In addition, we also recommend that when you are checking calibrations that you run several samples of grain with known weights and moistures through the system to ensure accurate moisture and weight calibrations.

All Systems

- Clean the combine battery terminals to ensure a good power and good connection.
- Inspect all cables for mice damage.
- Make sure all cables are secure (“click” lock into place) and are not touching or interfering with the weigh bucket assembly.

- If equipped with a pneumatic air system, check the filters and lubricator for contamination. Replace as necessary. Close the petcock valve on the air tank and charge the system up to 120 PSI. Check for air leaks. Operating pressure should be regulated to 50 PSI.
- Check the limit switches for proper function (adjust if needed).
- Check the actuator operation for each door assembly for normal operation. Slow-moving actuators are usually an indication of a plugged metal porous vent on exhaust port of solenoid. Replace or clean as needed.
- Ensure the weigh bucket or pan moves freely. Verify air hoses and cables are not interfering with the weigh pan.
- Check the actuators and slides for proper function and adjustment. If needed, lubricate the slides with DRY graphite to minimize gum or chaff buildup. **CAUTION:** Do not use wet lubricants on the gate assemblies.
- Run **DIAGNOSTIC** menu checks on the load cells, moisture sensor, and level detect sensor as outlined in the Diagnostics section of this reference guide.
- Check weight and moisture calibrations.

Recommended Maintenance during Harvest (each morning)

- If your GrainGage is equipped with pneumatics, drain the water from the air tank using the petcock relief valve.

Chapter 8

- Drain water from the lubricator/water separator bowl by pulling down on the drain plug.
- Blow chaff and broken kernels out of and from around the weight bucket or pan.
- Check the load cell calibration using a known weight.
- Check the compressor air filters.

Recommended Post-Harvest Maintenance

- Print setups and moisture curves. Save and file this information in an area where it can be found in future years if needed.
- With about 120 PSI forced air, blow all chaff and broken kernels out of and from around the weigh bucket or pan. With the Classic GrainGage, be sure to get around the back load cell. Blow upward (from the bottom of the GrainGage) on each overload protection pin to ensure all the debris is out of the channels and away from the protection pins.
- Avoid using water to clean in and around the weigh systems. If you use a sprayer washer to clean the combine, be sure to keep the water away from all sensors and cabling.
- Disconnect the air hose from the GrainGage and let the air run (free-flow) for at least 5 minutes.
- Drain the air tank.
- Drain the pneumatic filter bowls and blow them dry with forced air.

- Retract all the cylinder rams into the housing.
- If mice have been a problem in the past, place mouse poison or traps in areas where mice might appear. Moth balls tend to help as well.
- If your Harvest Data System console is mounted outside of the cab (e.g. exposed to the elements), we recommend removing or covering the control box. It is best to store your system in a warm and dry environment.
- If the combine is not protected from the weather, cover any exposed cable ends (connectors) with plastic bags and secure tightly with twist-ties or rubber bands.

Installation and Maintenance Tips

We suggest the following tips when installing and/or maintaining the Harvest Data System:

When using pneumatics:

- Install a three to five gallon reservoir air-tank. This tank must have a petcock type drain valve or an electronically controlled drain valve to allow any water that accumulates inside the tank to be drained.
- Install the Bosch Combo filter/regulator as close to the Classic GrainGage as possible
- If areas of high humidity or when using a lubricated compressor, it is recommended to install a Kaeser Model KOR-20.

Chapter 8

- Replace the Kaeser filter every 100,000 plots or when the indicator is mostly RED. Use the “USOR-20” replacement filter element (sourced by Juniper Systems).

CAUTION: Certain compressor oils, chemicals, household cleaners, solvents, paints, and fumes may damage the plastic bowl. Be sure that you use cleaning chemicals that are safe for polycarbonate material.

- Adjust the oil delivery rate to one drop for every 15 to 20 cycles of a gate. The operation of the oil delivery rate may drop after an extended period of use. If this happens, clean the lubricator and all its air and oil distribution tubes with kerosene. We recommend replacing the lubricator every five to six years or if the color becomes white or cloudy.
- Use #10 (90 SSU) or lighter oil in your lubricator. We recommend using non-detergent, semi-synthetic or non-synthetic air-tool oil (replace yearly). Do not over fill the lubricator bowl.
- Use special anti-freeze lubricant if you are using the system in temperatures below freezing. This oil is a special blend that can be purchased from Juniper Systems or most retail stores. The anti-freeze oil is not an additive and must not be mixed with other oils.

Operating Specifications

The following operation specifications show the maximum

pressure and temperature ratings for the filter bowl:

| <i>Bowl Type</i> | <i>PSIG</i> | <i>Temperature</i> |
|-------------------------|--------------------|---------------------------|
| Transparent Plastic | 150 (10.3 bar) | 125° F (52° C) |
| Metal | 200 (14 bar) | 175° F (79° C) |

Air Regulator

The regulator should be adjusted between 50 and 85 PSI. Colder temperatures may require higher pressures.

To adjust the pressure, complete the following steps:

1. Unlock the regulator by pulling down on the adjusting valve.
2. Turn the regulator clockwise to increase the pressure and counter clockwise to decrease the pressure.

Lubricator

Note: Cylinder manufacturers no longer recommend using lubricating oil. In order to stop using oil, replace all solenoids and cylinders and blow out air lines.

Changing the Oil

To change the oil, complete the following steps:

1. Release the air pressure from the air lines (through the air control valve).
2. Remove the four mounting screws that hold the plastic bowl securely to the metal housing.
3. Gently pull down on the bowl while gradually tipping the bowl back and forth until it is removed.

Note: Be careful not to drop the plastic bowl from the metal bowl guard when emptying the oil.

4. Inspect the plastic bowl for deterioration or cracks. Replace as necessary.
5. Clean with a dry or water-dampened cloth.
6. Refill the bowl to the level as indicated on the metal bowl guard. Do not overfill the lubricator. This causes it to malfunction and results in not providing the proper lubrication to the cylinders.

CAUTION: Install the metal bowl guard to minimize the danger of flying fragments. Be sure the lubricator has a metal bowl guard before pressurizing the system.

Adjusting the Lubricator

Your Bosch combination filter/ lubricator assembly is adjusted at the factory. If you are getting too much oil, you can adjust the assembly. To adjust the lubricator, follow these steps:

Adjustment set screw and oil viewing dome



Figure 8-1: Filter/lubricator assembly and set screw

For a simple adjustment, turn the oil flow adjustment screw clockwise until it stops. Turn the screw counterclockwise ½ turn to finish adjustment. If you wish to adjust the oil using a more thorough method, follow these steps:

1. The air system must be pressurized to operating pressure (approximately 50- 80 PSI).
2. Turn on the electronics of the Harvest Data system. On the laptop, go to the main FRS screen.
3. On the console, switch the Auto/Manual switch to Manual mode so you can cycle the system manually.
4. While watching the dropper in the oil viewing dome on top of the lubricator, cycle one of the gates 15 times using the Open and Close switches. Complete one cycle every 1-2 seconds.

Note: The gates can be cycled while standing by the GrainGage by pressing the red button on the top of the control solenoid (mounted to the right inside wall of the GrainGage). If the lubricator is not mounted close enough to the GrainGage to cycle the door and watch the site dome, find an assistant to set the oil delivery drop rate.

5. Using a short-handled, flat-head screwdriver, adjust the set screw in the lubricator so that a drop of oil falls inside the oil viewing dome every 15-20 cycles (cycle one door

at a rate of one complete cycle every one to two seconds).

Replacing the Kaeser Filter USOR-20

1. Release the air pressure from the air lines by either opening the relief valve on the GrainGage or opening the drain valve on the air tank.
2. Turn the filter bowl housing $\frac{1}{4}$ turn counterclockwise and gently pull down on the bowl while gradually tipping the bowl back and forth until it is removed.
3. Remove the RED filter by turning it counterclockwise (as if removing a right handed screw).
4. Install new filter and tighten finger-tight.
5. Reinstall filter bowls housing in reverse order as removed.

Cylinder Removal and Installation

The cylinders on the Classic GrainGage can become worn from constant use and eventually wear out. As the cylinder wears out it leaks air, or responds slowly to the open and close command front console. When this starts happening, its time to remove your old cylinders and install new ones.

Load Cell Replacement Procedures

CAUTION: The load cells in this system are extremely delicate. DO NOT allow your arms or tools to press upon the weigh pan or individual load cells at any time.

Tools Needed

We recommend you have the following tools on hand to aid in replacement of the load cells:

- Allen wrenches (5/32" and 3/16")
- Socket set (3/8" drive with 7/16" socket and short extension)
- 7/16" end wrench (preferably 2" long)
- 0.020 feeler gage or load cell adjusting shim.
- Loc-Tite 242 Thread Locker
- Flat-head screwdriver (4.0 x 60 mm)
- #3 Phillips screwdriver

Procedures

1. Disconnect the air supply to the GrainGage by turning the air control valve to the off position.
2. Position the laptop so that you can see the display while working on the GrainGage.
3. Position the shipping stops (PVC tube) under the weigh pan so the weight is OFF the load cells.
4. Enter the Harvest Data program and at the Main Menu select **Diagnositics** and **Load Cells**. Your display will show four for the 800 system. The 800 will be labeled A, B, C, and Total:

Chapter 8

- Cell A This is the combination of the two left hand load cells. (LdA1=front and LdA2=back)
- Cell B This is the total of the right load cell.
- Total This is the total of all three load cells.

5. Take note of the **Cell A**, **Cell B**, and **Total** voltages. This is the zero offset for each load cell.

Note: During the following procedures watch the total voltage column to make sure that it does not exceed a specification of $\pm 1.5\text{mV}$. Ideally, this reading should stay as close to 0.00 mV as possible.



Figure 8-2: GrainGage exit sleeve (bottom view)

This procedure ensures that you are not inadvertently placing excessive upward or downward pressure on the load cells. When working on the left-hand load cells (LdA1 and LdA2), disconnect the load cell you are not

working on. This allows you to see the voltage of each individual load cell.

6. Using the 7/16" end wrench or 7/16" socket and extension, remove the four 1/4-20 exit sleeve bolts from the bottom of the GrainGage and remove the exit sleeve (refer to Figure 8-2 GrainGage Exit Sleeve).
7. Slide the bottom gate halfway open so the gate connecting pin on the actuator aligns with the hole in the weigh pan (refer to Figure 8-3 GrainGage Weigh Pan Assembly).
8. Remove the E-rings from the bottom gate connecting pin and push the pin out. Close the bottom gate.

Note: The E-ring can be removed by using a screwdriver to pry the edge of the E-ring away from the pin until it snaps free.

9. Disconnect the black air hoses from the actuator cylinder by pressing the orange collar into the cylinder body and pulling the hose out (take note of their proper positions).
10. Using the 7/16" socket and ratchet (without extension), remove the two 1/4-20 bolts on the gate guide closest to you (front gate guide) and remove the three 1/4-20 mounting bolts from the bottom weigh chamber (two in front and one in back). Set the gate guide aside for future reference (Refer to Figure 8-3).
11. Using a 5/32" Allen wrench, remove the guide pin located at the left front corner of the weigh pan, being careful not to exert any pressure on the load cell.
12. Using the 5/32" Allen wrench, remove the guide pin located on the right side of the weigh pan (in front of the actuator).

13. Make sure the shipping stops are disabled by following the procedures outlined below:
 - a. Remove the three shipping stop hex bolts.
 - b. Remove the three PVC tubes between the weigh pan assembly and the bottom of the GrainGage.

Note: Keep these parts in a convenient place in case you need to ship the GrainGage by mail. The shipping stops are not needed when the GrainGage is mounted to the combine.

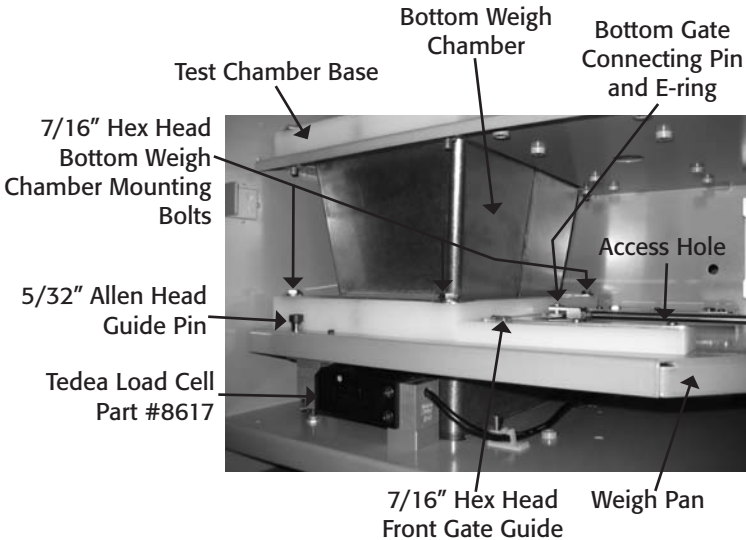

Figure 8-3: GrainGage weigh pan assembly

14. Lift the lower chamber up firmly against the top of the test chamber base and carefully slide the white weigh chamber base out of the GrainGage. The lower stainless steel chamber has a 1/8" lip on the bottom skirt. When removing, make sure to lift the white base over the protruding rubber nipple on the weigh pan.

CAUTION: Be careful not to exert too much downward pressure on the load cell when removing the weigh chamber base.

Note: If removing the base is too difficult, the top and middle 1/4-20 chamber mounting bolts (three places on each level) can be loosened to allow more movement.

15. Remove the bottom weigh chamber. Set the chamber and the base aside for future reference.
16. Disconnect the actuator limit switch cable. The connector for this cable is located on the break-out box on the middle level. Press the lock tab on the side of the connector to release it from the break-out box.
17. Carefully lift the weigh pan up and out of the GrainGage.
18. Using the 3/16" Allen wrench or a #3 Phillips screwdriver, remove the load cell mounting bolts. Then remove the load cell.
19. Remove the two 3/16" Allen screws from the aluminum spacer attached to the load cell and re-install the spacer on the new load cell.

Note: Make sure the spacer is aligned with the edge of the load cell before tightening the bolts.

Note: Before re-assembling, clean all the screws with a fine wire brush. Use #242 Loc-Tite on all screws during reassembly.

20. Remove the load cell stop (hex bolt) from the end of the load cell.

21. Install the load cell stop in the end of the new load cell until there is a 1/16" gap between the load cell and the hex head. Use #242 Loc-Tite when reassembling.
22. Disconnect the old load cell cable and secure the new load cell cable in its place. Use plastic ties to hold the cable away from the weigh pan.
23. Place Loc-Tite on the two load cell mounting bolts and install the new load cell on top of the load cell mounting spacer. Make sure the load cell protection pin is centered under the load cell stop bolt.

WARNING: Make sure the load cell stop is not touching the overload protection pin when tightening the load cell mounting bolts as this may cause the load cell to stretch or overload.

24. Adjust the overload protection pin down (or load cell stop up if the pin will not adjust) until you can just slide the 0.20 shim between the overload protection pin and load cell stop. The shim should slide out with between 0.010 and 0.020 voltage change on the display of the Field Computer in the **Diagnostics** menu.

Note: Make sure the protection pin and load cell stop are securely in place with #242 Loc-Tite.

25. After the load cell is completely installed, use the following procedures to check that the load cell is functioning properly:
 - a. Select **Load Cells** from the **Diagnostic** menu and make sure the voltage for the load cell you are testing is between 0.00 mV and +.150 mV (this is the

zero offset).

- b. Make sure all three load cells are plugged in and lock collars are secure.
- c. Retare the weights.

Note: If the limit switches are enabled, you will need to bypass the *Gate Obstruction* message.

- d. Write down the reading of the total weight of all three load cells (should be 0.00 lbs).
- e. Place an eight-lb. weight on each load cell and write down the total weight each time.

Note: The weight should be similar (eight-lb.) on each load cell and should repeat the same reading each time the weight is placed on it. When the weight is removed, it should return to its same zero reading.

- f. Place an 11 lb. weight on each load cell and note the total weight each time.

Note: The total weight should not exceed 1.5 lbs. at any time. The overload protection pin should limit the weight on each load cell.

26. Install the weigh pan assemblies in reverse order of disassembly (starting with step 17 and working backward to step 1). Remember to place Loc-Tite on all mounting bolts.

Note: When installing the weigh pan, skip step 13. You do not need to reinstall the shipping stops.

GrainGage Chamber Installation

Preparation

Following are the instructions for removing the chambers on the GrainGage and installing new chambers. During this process you will either be installing 3-liter chambers in place of 1.5-liter chambers, or 1.5-liter chambers in place of 3-liter chambers. When removing your existing chambers make sure that you keep track of all the screws you remove because you will use these same screws when you install the new chambers. Typically this process takes about 40 minutes.

Tools Needed

- Medium Phillips screwdriver
- Medium flat-head screwdriver
- 7/16" shallow socket (recommended) or 7/16" combination wrench

Procedure

Removing the Existing Chambers

Use the following steps to remove the existing chambers:

1. Remove the GrainGage door.
2. Using a Phillips screwdriver, remove the two screws holding the level detect sensor to the hopper on the top shelf. Rotate the sensor out of the way toward the back right corner.
3. Remove the side screws from the moisture sensor on the middle level using a Phillips screwdriver. Slide the moisture sensor out and place it out of the way.

4. Starting with the top level gate closed, slide the pneumatic actuator rod to the right until the pin connecting the actuator rod and the gate is directly over the access hole on the bottom of the shelf. Using a flat-head screwdriver, remove the E-ring from the actuator pin assembly. Remove the pin from the actuator and slide the actuator rod back toward the actuator. (If you remove the slides from the plastic housing, recognize that the top shelf slide is 2" shorter than the middle shelf slide.)
5. Repeat step 4 with the middle level gate.
6. Remove the 1/4-20 cap screws from the slide guides on both levels, and remove the guide.
7. Remove the three 1/4-20 cap screws from the plastic slide housing on both levels.
8. Lift the middle chamber up toward the top of the GrainGage and remove the middle level plastic slide housing from the shelf. Pull the chamber down and remove from the GrainGage.

CAUTION: Be careful not to put weight on the bottom chamber or the weigh pan. This may damage the load cells.
9. To remove the top chamber, repeat step 7 above (substituting **top** for **middle**).

Installing the New Chambers

Use the following steps to install the new chambers:

Chapter 8

1. Slide the top level chamber into place making sure it fits into the groove in the top gasket.
2. Lift the top chamber up toward the top of the GrainGage and push the plastic slide housing into place beneath the chamber.
3. Repeat steps 1 and 2 to insert the middle chamber.

CAUTION: Be careful not to put weight on the bottom chamber or the weigh pan. This may damage the load cells.

4. Insert the three 1/4-20 cap screws into the holes on the plastic slide housing on each level and tighten them.
5. Place the plastic slide guides in place (use the inner holes for 1.5-liter chamber and the outer holes for 3-liter chamber). Insert the 1/4-20 cap screws into the holes and tighten them. Do this for both levels.
6. Starting with the middle level gate open, slide the pneumatic actuator rod to the left until the hole for the pin is directly above the access hole. Slide gate to meet actuator rod end and replace pin. Snap E-ring back into place. Repeat this step for the top level gate.
7. Slide the moisture sensor into place. Insert the screws into the side holes on the moisture sensor and tighten them. (The screws for the moisture sensor are longer than the screws for the level detect sensor.)
8. Rotate the level detect sensor into place. Ensure that the probes are pointing down. Insert the screws and tighten

them.

9. Replace the GrainGage door.

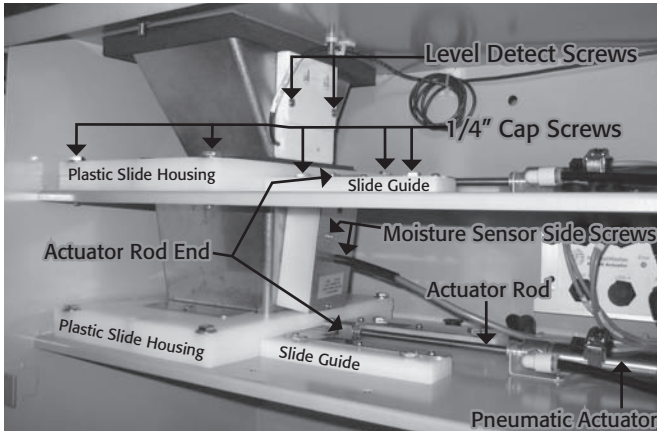

Figure 8-4: GrainGage chamber

If you have any maintenance questions, please contact a Juniper Systems Technical Service Representative at (435) 753-1881 or email them at techsupport@junipersys.com.

Return for Repair Procedure

In the event that your Harvest Data System needs repairs, go to www.harvestmaster.com and choose **Support > Repair Services** for a Returned Materials Authorization (RMA) number. Please have the following information ready:

- Serial number
- Model number
- Name and company/university/agency
- Phone and fax numbers

Chapter 8

- Clear description of problem
- Purchase Order number and billing address

Under the Premium Support Agreement, HarvestMaster will ship you a replacement loaner Next Day Federal Express or UPS Red. To avoid any problems in the return procedure, complete the following steps:

1. Once you receive the loaner unit, package your equipment (if the existing box is still good) in the same box and ship it Federal Express, Next Day Air Mail, or UPS Red.
2. Fill out the shipping and RMA forms that were included with your loaner equipment and include a description of the failure. The more information you can supply concerning the malfunction and the circumstances under which it occurred, the quicker our technicians can complete the repair.
3. Package the unit properly to avoid shipping damage.
4. Write the RMA# on the package you ship.

Your equipment will be repaired and returned to you. After receiving your repaired equipment, you will be authorized a period in which to return the loaner unit before you will be billed for it. There is an annual service and support fee that allows you to have this service. Please call for detailed information and pricing.

APPENDIX

Appendix A: Warranty

Appendix B: Mounting Diagrams

Appendix C: Cable Wiring Diagrams for the HM-401

Appendix D: Cable Wiring Diagrams for the HM-800

Appendix A

Warranty

Limited Warranty

Hardware

All products manufactured by Juniper Systems, Inc. (Juniper Systems) when properly installed, calibrated, and operated in accordance with instruction manuals accompanying the hardware and used for the purpose for which the hardware was designed, shall be free from defects in materials and workmanship for a period of one (1) year from the date of shipment.

In the event a defect in materials or workmanship is discovered and reported to Juniper Systems within the one-year period, Juniper Systems will, at its option, repair the defect or replace the defective product. Juniper Systems' obligation hereunder will be limited to such repair or replacement.

The customer shall have the responsibility to ship the defective equipment to Juniper Systems with all cost of shipment prepaid. After repair or replacement Juniper Systems will, at their own expense, ship the replacement or repaired item back to the customer using the same type of carrier.

Software

Software products that are designed by Juniper Systems for use with a hardware product and that are properly installed on that hardware product are warranted to the end user not to fail to execute their programming instructions due to defects in materials or workmanship for a period of one year from date of delivery.

If Juniper Systems receives notice of such defects during the one-year warranty period, Juniper Systems shall, at its option, repair or replace the defective software media. Warranty is limited to repair or replacement of software media.

The warranties provided herein do not apply in the case of improper or inadequate maintenance or in the case of repair by any person not previously authorized in writing by Juniper Systems to do such maintenance or make such repairs.

These warranties likewise do not apply where the products have been operated outside the environmental specification of the product, where software products other than those specified by Juniper Systems have been used, or where attempts at software interface have been made by any person not previously authorized by HarvestMaster to perform such interfacing operations.

Disclaimer of Warranties

The warranties set forth herein are in lieu of all other warranties of Juniper Systems, whether written, oral or implied. Juniper Systems makes no warranties regarding its products (hardware or software), including without limitation warranties as to merchantability, fitness for a particular purpose, any warranty arising from course of performance, course of dealing, or usage of trade whether any of the foregoing warranties are either expressed or implied.

Juniper Systems specifically makes no warranties as to the suitability of its products for any particular application. Juniper Systems shall in no event be liable for special, incidental, or consequential damages in connection with or arising out of the furnishing, performance or use of any product covered by this agreement whether such claim is based upon warranty (express or implied), contract, strict liability, negligence, or otherwise.

Updates or Modifications

Juniper Systems shall be under no obligation to update or modify its products except as herein noted to correct program errors. Furthermore, the customer agrees that all representations and warranties contained herein shall be immediately null and void in the event of any modification, alteration, or change in or to any product affected by or on behalf of the customer except for a change made by Juniper Systems.

Removal of Serial Number

Removal of the Juniper Systems serial number label from an instrument will void any warranty on the said instrument. Juniper Systems will not repair or update an instrument and return it to an individual if the instrument is without the said serial number label.

Extended Warranties

Juniper Systems offers a variety of warranty options to extend coverage beyond the standard warranty. You can contact Juniper Systems Customer Service Department for details at (435) 753-1881 (6 am - 5 pm MST, Mon-Fri).

Appendix B

Mounting Diagrams

Below is pictured the system console mounting diagram.

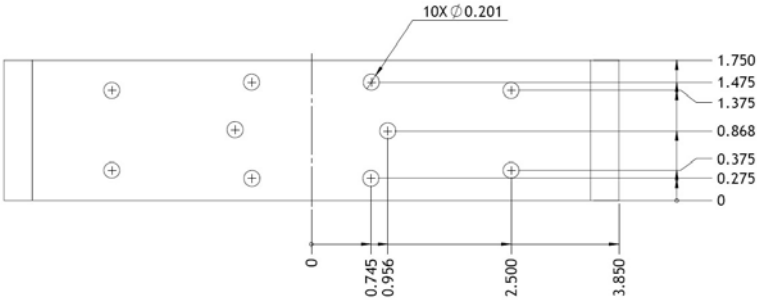

The next two diagrams are for mounting the printer.

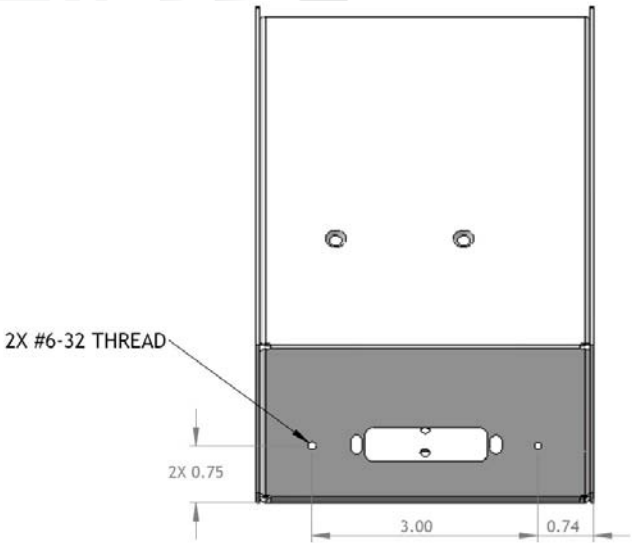

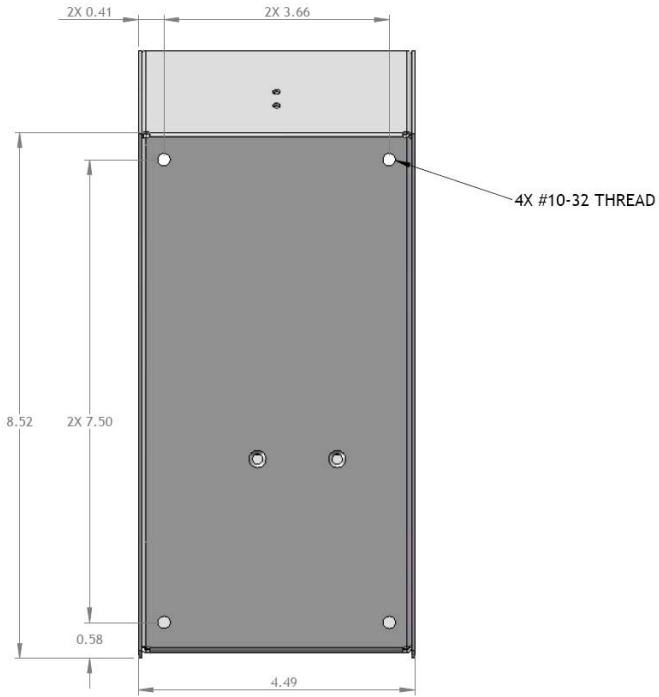

Appendix

The following diagrams are for mounting the Classic GrainGage.

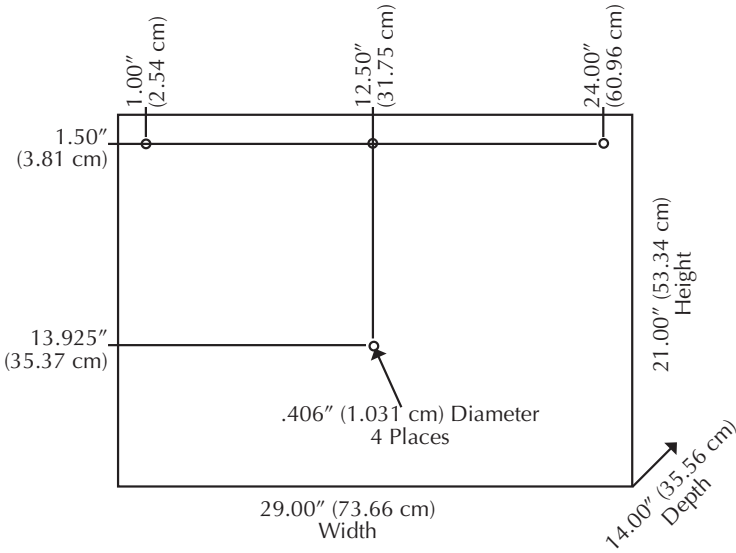

Appendix C

Cable Wiring Diagrams for the HM-800

Cable Connections for HM-800

Within the HM-800 there are several components. Figure C-1 shows the components wired on the stand.



Figure C-1: Front view of HM-800 components

Figure C-2 shows the cable connections from the HM-800 System Console and modules to other components.

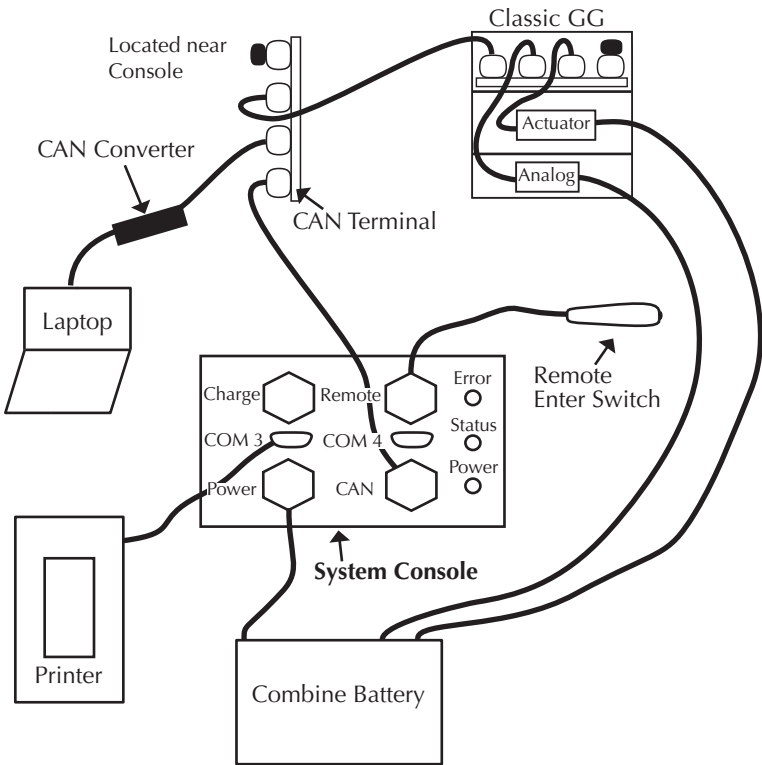

Figure C-2: Cable connections for the HM-800

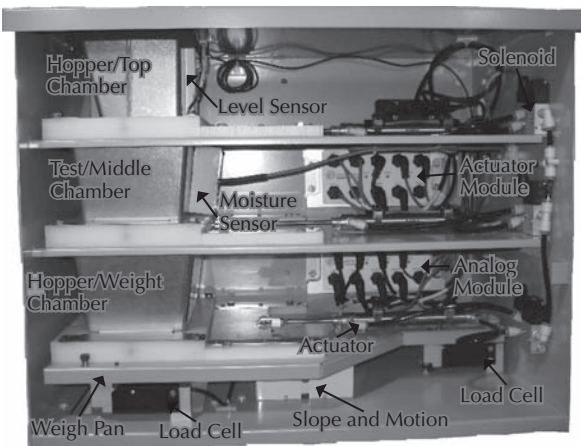

Figure C-3: Basic Classic GrainGage System

ACTUATOR

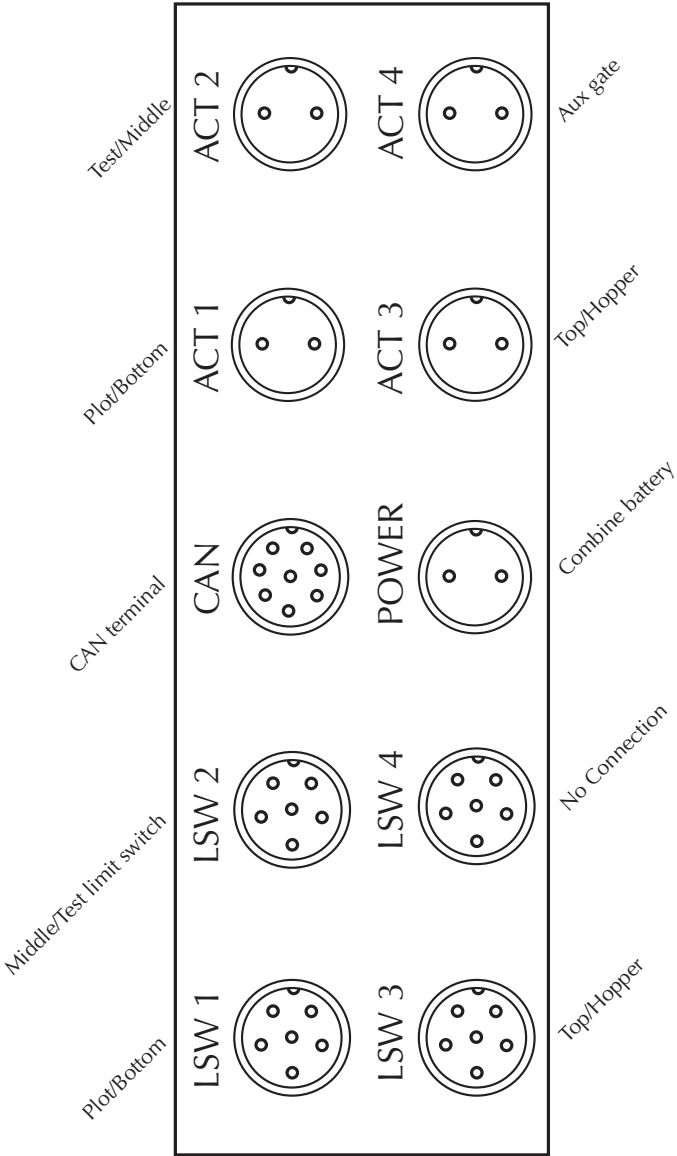

Figure C-4: Cable connections for the actuator module

ANALOG

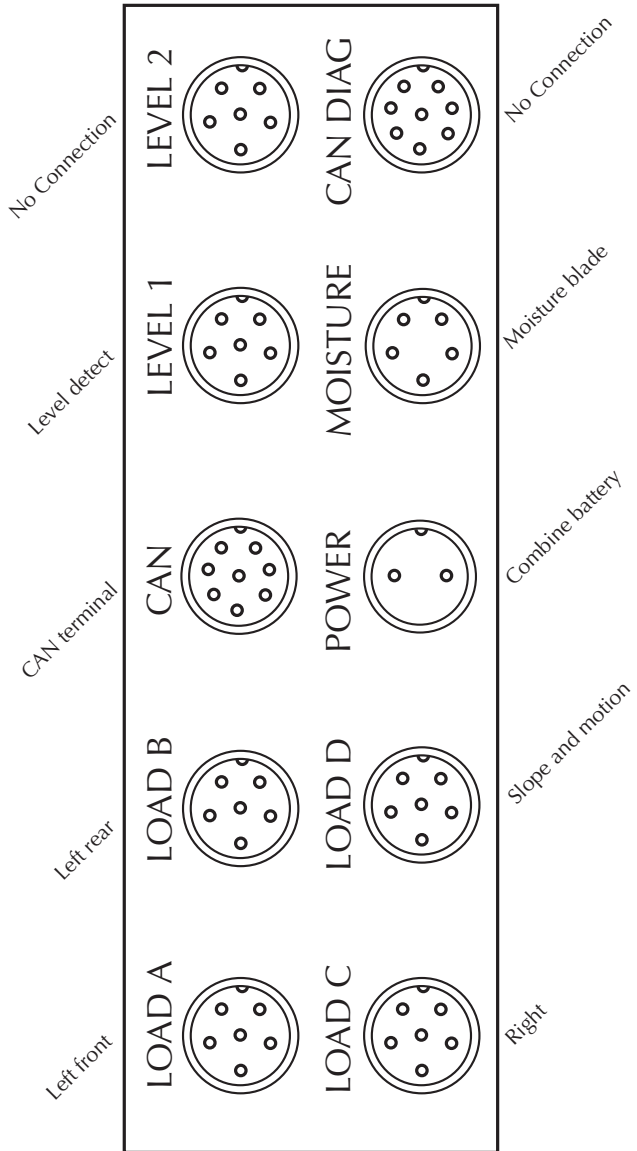
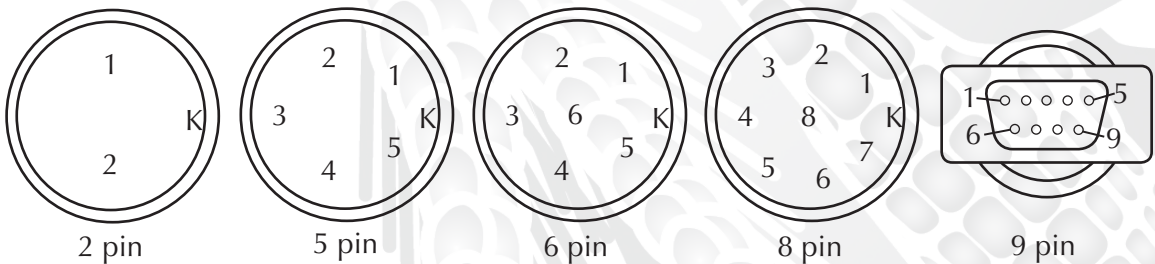
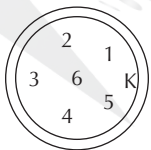

Figure C-5: Cable connections for the analog module

Connector Wiring Diagrams for the HM800



| <i>Analog Module</i> | <i>Classic</i> | <i>Pin</i> | <i>Connection</i> | <i>Description</i> |
|-------------------------|----------------|------------|-------------------|--------------------|
| Level 1 <i>6-pin</i> | Level Detect | 1 | Red | Excite |
| | | 2 | Shield | Ground |
| | | 3 | Black | Digital In |
| | | 4 | N/C | N/C |
| | | 5 | N/C | N/C |
| | | 6 | N/C | N/C |



| Analog Module | Classic | Pin | Connection | Description |
|-------------------------|-------------------------|------------|-------------------|--------------------|
| Level 2 <i>6-pin</i> | N/A | 1 | Red | Excite |
| | | 2 | Shield | Ground |
| | | 3 | Black | Digital In |
| | | 4 | N/C | N/C |
| | | 5 | N/C | N/C |
| | | 6 | N/C | N/C |
| Load A <i>6-pin</i> | Front Left Load Cell | 1 | Green | Excite |
| | | 2 | N/C | N/C |
| | | 3 | Red | Signal + |
| | | 4 | White | Signal – |
| | | 5 | Black | Excite Gnd |
| | | 6 | Shield | Chassis Gnd |
| | | N/C | Brown | N/C |
| | | N/C | Blue | N/C |

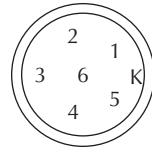
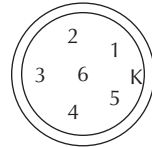

| <i>Analog Module</i> | <i>Classic</i> | <i>Pin</i> | <i>Connection</i> | <i>Description</i> |
|------------------------|------------------------|------------|-------------------|--------------------|
| Load B <i>6-pin</i> | Back Left Load Cell | 1 | Green | Excite |
| | | 2 | N/C | N/C |
| | | 3 | Red | Signal + |
| | | 4 | White | Signal – |
| | | 5 | Black | Excite Gnd |
| | | 6 | Shield | Chassis Gnd |
| | | N/C | Brown | N/C |
| | | N/C | Blue | N/C |
| Load C <i>6-pin</i> | Right Load Cell | 1 | Green | Excite |
| | | 2 | N/C | N/C |
| | | 3 | Red | Signal + |
| | | 4 | White | Signal – |
| | | 5 | Black | Excite Gnd |
| | | 6 | Shield | Chassis Gnd |
| | | N/C | Brown | N/C |
| | | N/C | Blue | N/C |

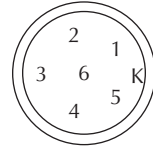
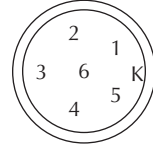

| Analog Module | Classic | Pin | Connection | Description |
|------------------------|-----------------|------------|-------------------|--------------------|
| Load D <i>6-pin</i> | Internal SMS | 1 | Green | Excite |
| | | 2 | N/C | N/C |
| | | 3 | Red | Signal + |
| | | 4 | White | Signal – |
| | | 5 | Black | Excite Gnd |
| | | 6 | Shield | Chassis Gnd |
| | | N/C | Brown | N/C |
| | | N/C | Blue | N/C |
| CAN <i>8-pin</i> | | 1 | Red | CAN Power |
| | | 2 | Yellow | CAN + |
| | | 3 | Black | CAN Gnd |
| | | 4 | Green | CAN – |
| | | 5 | N/C | N/C |
| | | 6 | N/C | N/C |
| | | 7 | N/C | N/C |
| | | 8 | N/C | N/C |

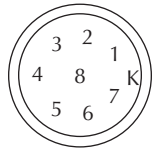
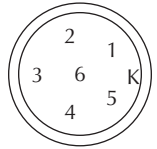

| <i>Analog Module</i> | <i>Classic</i> | <i>Pin</i> | <i>Connection</i> | <i>Description</i> |
|--------------------------|---------------------|------------|-------------------|--------------------|
| CAN-DIAG <i>8-pin</i> | CAN | 1 | Red | CAN Power |
| | | 2 | Yellow | CAN + |
| | | 3 | Black | CAN Gnd |
| | | 4 | Green | CAN – |
| | | 5 | N/C | N/C |
| | | 6 | N/C | N/C |
| | | 7 | N/C | N/C |
| | | 8 | N/C | N/C |
| Moisture <i>5-pin</i> | Moisture EM Sens | 1 | Red | Excite |
| | | 2 | Black | Ground |
| | | 3 | Green | Signal + |
| | | 4 | White | Signal – |
| | | 5 | Shield | Ground |
| Power <i>2-pin</i> | Power | 1 | Black | Ground |
| | | 2 | Red | +12 V |

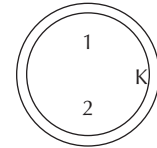
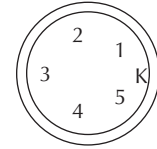
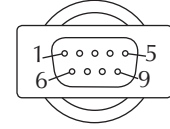

| <i>Actuator Module</i> | <i>Classic</i> | <i>Pin</i> | <i>Connection</i> | <i>Description</i> |
|-------------------------------|-----------------------|----------------------------|--|---|
| Act 1 <i>2-pin</i> | Bottom Plot Act | 1 2 | Red Black | Power Ground |
| Act 2 <i>2-pin</i> | Middle Test Act | 1 2 | Red Black | Power Ground |
| ACT 3 <i>2-pin</i> | Top/Hopper Act | 1 2 | Red Black | Power Ground |
| Act 4 <i>2-pin</i> | Aux Act | 1 2 | Red Black | Power Ground |
| LSW 1 <i>6-pin</i> | Bottom Plot LSW | 1 2 3 4 5 6 | Red Black White N/C N/C N/C | Excite Ground Signal N/C N/C N/C |

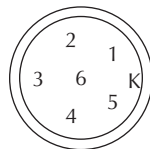
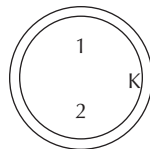

| <i>Actuator Module</i> | <i>Classic</i> | <i>Pin</i> | <i>Connection</i> | <i>Description</i> |
|------------------------|-----------------|------------|-------------------|--------------------|
| LSW 2 <i>6-pin</i> | Middle/Test LSW | 1 | Red | Excite |
| | | 2 | Black | Ground |
| | | 3 | White | Signal |
| | | 4 | N/C | N/C |
| | | 5 | N/C | N/C |
| | | 6 | N/C | N/C |
| LSW 3 <i>6-pin</i> | Top/Hopper LSW | 1 | Red | Excite |
| | | 2 | Black | Ground |
| | | 3 | White | Signal |
| | | 4 | N/C | N/C |
| | | 5 | N/C | N/C |
| | | 6 | N/C | N/C |
| LSW 4 <i>6-pin</i> | N/A | 1 | Red | Excite |
| | | 2 | Black | Ground |
| | | 3 | White | Signal |
| | | 4 | N/C | N/C |
| | | 5 | N/C | N/C |
| | | 6 | N/C | N/C |

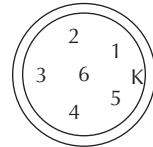
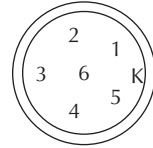
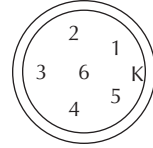

| Actuator Module | Classic | Pin | Connection | Description |
|------------------------|----------------------|------------|-------------------|--------------------|
| CAN <i>8-pin</i> | CAN (patch Cable) | 1 | Red | CAN Power |
| | | 2 | Yellow | CAN + |
| | | 3 | Black | CAN Gnd |
| | | 4 | Green | CAN – |
| | | 5 | N/C | N/C |
| | | 6 | N/C | N/C |
| | | 7 | N/C | N/C |
| | | 8 | N/C | N/C |
| Power <i>2-pin</i> | Power | 1 | Black | Ground |
| | | 2 | Red | +12 V |

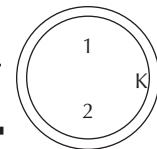
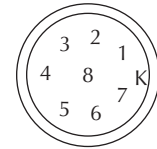

| System Console | Classic | Pin | Connection | Description |
|-------------------------------|----------------|------------|-------------------|--------------------|
| Allegro Power <i>2-pin</i> | | 1 | Stria | +12 V |
| | | 2 | Black | Ground |
| Remote <i>5-pin</i> | | 1 | Black | Input |
| | | 2 | Green | Ground |
| | | 3 | Red | Power |
| | | 4 | N/C | N/C |
| | | 5 | N/C | N/C |

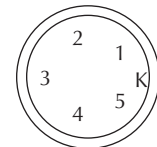

| <i>System Console</i> | <i>Classic</i> | <i>Pin</i> | <i>Connection</i> | <i>Description</i> |
|-----------------------|----------------|------------|-------------------|---------------------|
| Com 3 | Printer | 1 | N/C | N/C |
| | | 2 | RXD | Receive Data |
| | | 3 | TXD | Transmit Data |
| | | 4 | DTR | Data Terminal Ready |
| | | 5 | GND | Ground |
| | | 6 | DSR | Data Set Ready |
| | | 7 | RTS | Request to Send |
| | | 8 | CTS | Clear to Send |
| | | 9 | N/C | N/C |
| Com 4 | | 1 | N/C | N/C |
| | | 2 | RXD | Receive Data |
| | | 3 | TXD | Transmit Data |
| | | 4 | DTR | Data Terminal Ready |
| | | 5 | GND | Ground |
| | | 6 | N/C | N/C |
| | | 7 | RTS | Request to Send |
| | | 8 | CTS | Clear to Send |
| | | 9 | RI | Ringing In |

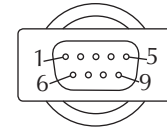
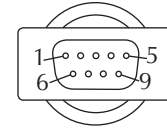

| <i>System Console</i> | <i>Classic</i> | <i>Pin</i> | <i>Connection</i> | <i>Description</i> |
|-----------------------|----------------|------------|-------------------|--------------------|
| Power <i>2-pin</i> | Power | 1 | Black | Ground |
| | | 2 | Red | +12 V |
| CAN <i>8-pin</i> | CAN | 1 | Red | CAN Power |
| | | 2 | Yellow | CAN + |
| | | 3 | Black | CAN Gnd |
| | | 4 | Green | CAN - |
| | | 5 | N/C | N/C |
| | | 6 | N/C | N/C |
| | | 7 | N/C | N/C |
| | | 8 | N/C | N/C |

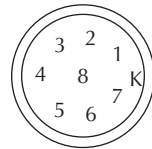
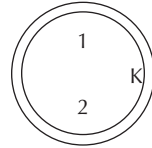



I n d e x

Index

A

Actuator 117
actuator 37, 51, 87
 controls screen 51
 setup screen 37
air regulator 91
Analog Module 112

C

cables 14, 86
 2 pin 112
 5 pin 112
 6 pin 112
 8 pin 112
 9 pin 112
calibrate 86
 accuracy 43
 Classic Graingage 18
 equations 30
 load cells 43
 moisture 24
 temperature 28, 29, 30
Classic
 automatic moisture correction 28
 preparing for harvest 18

D

data
 collection mode 65
 preparing to collect 64

DataLink
 exporting 77
 functions 72
 importing 73, 76
diagnostics 42, 44

E

enable
 Classic GrainGage 14
 slope and motion sensor 21
error codes 48

F

field map
 new 65
Field Research Software. *See* FRS
filter bowl 91, 94
FRS
 Note Taking 8

H

harvesting
 data. *See* data viewing
 navigation type 67
 circular navigation 67
 sequential navigation 67
 serpentine navigation 67
 route 67
 starting location 66
harvest template. *See* traits template screen
HM-800
 system console 108

I

installing
 cylinder 94
 FRS 9
 harvest data system 89

Index

K

Keaser filter 94

L

level detector sensor screen 50

current 50

tare 50

tare value 50

trip point 50

level sensor

settings screen 34

light emitting diode. *See* moisture sensor LED codes

limit switch 38

load cell 43

checking calibration 43

recalibrate 44

load cell screen 43

ref, Q 45

SM status 46

tare 46

total 45

voltage 45

weight 45

lubricator

oil 91

M

maintenance 89

Classic GrainGage 86

daily 86, 87

post-harvest 88

pre-harvest 86

master traits list. *See* traits

metric 21

- moisture 32, 46, 55
 - correction multiplier 28
 - sensor 22
 - error code 48
 - interpretation of codes 49
 - LED codes 47
 - temperature 29
- moisture curve 26, 30
 - adjusting 27, 29
 - copying 32
 - creating 26
 - default 24
 - default (graph) 25
 - deleting 31
 - editing 23
- moisture screen 46, 47
 - absolute volts 47
 - moisture 46
 - relative volts 46
 - select 47
 - tare 47
 - temperature 47
- mounting diagrams 104
 - Classic GrainGage 106
 - printer 104
 - system console 104

N

navigation type. *See* harvesting navigation type

O

- operating pressure 87
- operating specifications 90

P

- pneumatics 87, 89
- print calibrations 52

Index

R

- repair 105
- retare 47
- Returned Materials Authorization (RMA) 105

S

- SCCU
 - error 49
- Sensor Control and Conditiong Unit. *See* SCCU
- setup
 - two combines 38
- setup file 38
 - default 39
- single plot combine 66
- slope and motion sensor 20, 44
 - lighter weights 22
- starting plot cell 66

T

- tare 44
- timers 36
 - setup screen 36
 - weight time 36
- traits 54
 - adding 54
 - creating 54, 55
 - data source 56
 - description 56
 - master traits list screen 54
 - template screen 57
- traits management 58
- troubleshoot 42

V

Views

Form. *See* Form screen, Collect Data Form screen

list. *See* List screen

Spatial. *See also* Spatial screen

volts 47

W

warranty

disclaimer 102

extended 103

hardware 100

serial number 103

software 101

Windows CE 8

wiring

actuator 117

analog 112

system console 119

Index