

User Manual

Brand Name: Cedar

Model Name:CT7

FCC ID: 2ACUBCT7

Using this manual

Thank you for purchasing this tablet PC device. This device will provide you with high quality tablet PC communication and entertainment based on exceptional technology and high standards.

This user manual has been specially designed to guide you through the functions and features of your device.

Read me first

This user manual includes important safety precautions and operation guide. For avoiding accident, please read this manual carefully before operating your tablet.

- This tablet is suitable for the non-tropics.
- Do not connect your tablet with other equipment without permission.
- Prohibit strictly to use other specification of battery.
- Prohibit strictly to charge battery under the Mine.
- Do not leave your tablet in car with windows closed in hot summer.
- Do not turn the volume too high. If you feel tinnitus, please turn down the volume.
- Please charge when it is at below condition.
 1. Battery icon indicates no power.
 2. Tablet power off automatically and power off again soon after reboot.
- Do not disconnect your tablet while uploading, downloading or formatting to avoid a program error.
- Do not disassemble your tablet by yourself. Do not use alcohol, diluents or Benzene to clean its surface.
- Do not use your tablet at the area where electronic devices are forbidden, such as on flight.
- Do not operate your tablet when driving or walking at street.
- USB port is for data transmission and charging. (Please use the original USB cable).
- Do not turn off your tablet when it is connecting to PC or other device.

CONTENTS

Part 1 QUICK GUIDE	1
INTERFACE INTRODUCTION	1
INDICATOR ICON	2
PREPARATION	4
TURN ON/OFF THE MACHINE	4
CHARGE THE BATTERY	4
INSERT A MEMORY CARD.....	4
REMOVE THE MEMORY CARD.....	5
TO INSTALL SIM	5
CHECK RUBBER CONNECTORS	5
SPECIFICATION	5
Part 2 INSTRUCTION.....	6
LOCKING / UNLOCKING SCREEN	6
GET TO KNOW THE MAIN SCREEN	7
SETTING	8
SYSTEM SETTING	8
WIRELESS&NETWORKS	9
DEVICE	10
PERSONAL	10
SYSTEM.....	11
USB CONNECTION	11
POWER OFF	12

Part 1 QUICK GUIDE

INTERFACE INTRODUCTION

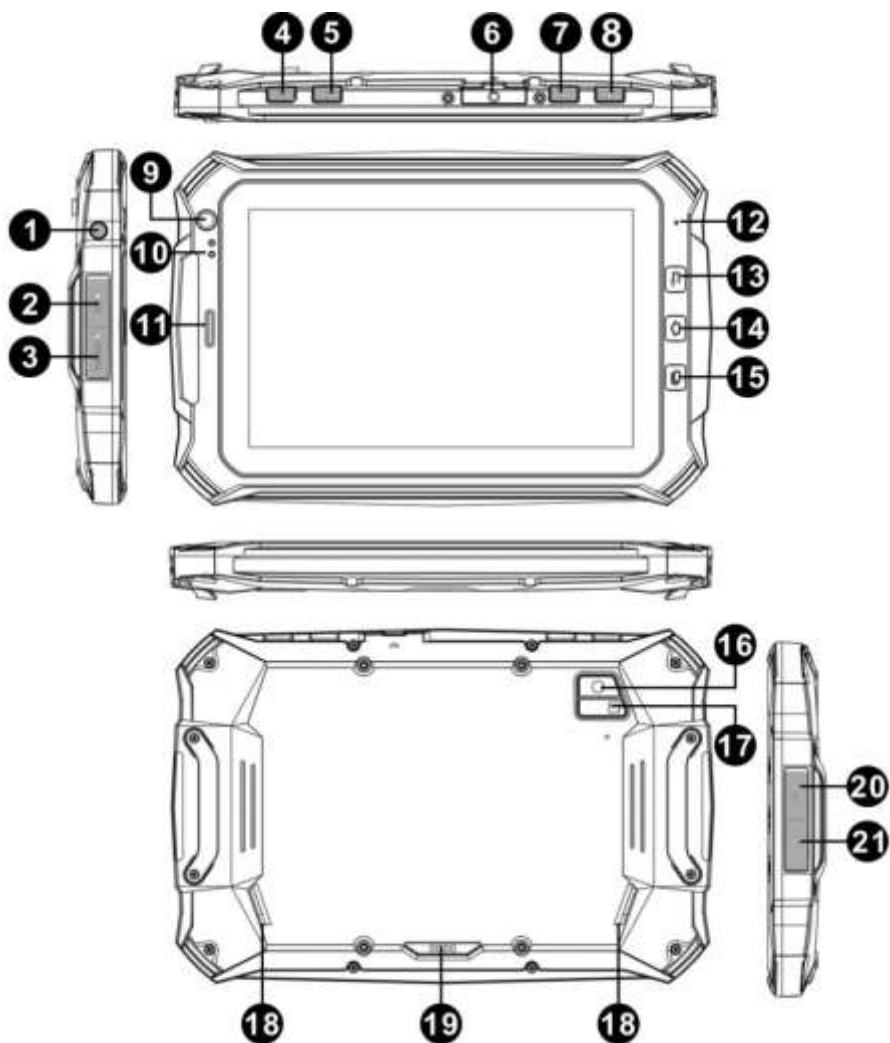















1. SOS Key: Poke the hole to make a SOS call.
2. Card Slot: use for SIM Card
3. Card Slot: use for TF-Card
4. Power Button: Press power button to select power off or press for 10 seconds to reset your tablet.
5. Camera Shortcut Key: use for opening Camera function
6. External Module Jack: use for connecting with external modules
7. Volume Button: to control the volume for –
8. Volume Button: to control the volume for +
9. Front Camera: 2.0 MP
10. Charging Lamp: to indicate the charging status of battery
11. Receiver: to listen to the coming call
12. MIC: Used for record
13. Shortcut key for Back to last step
14. Shortcut key for back to Home page
15. Shortcut key for back to Menu
16. Rear Camera: 8.0 MP
17. Flash for Rear Camera
18. Speaker: Left speaker and right speaker
19. Dock contactor: use for connecting PAD with Charging Dock for Charging
20. Micro USB: Connect to external USB device or other mobile device.
21. Earphone Jack: The built-in speaker will shut down automatically when plug in the earphone.

INDICATOR ICON

Icons shown on the display may vary depending on your region or service

provider.

ICON	FUNCTION
	Return
	Go to the opening screen
	Check the running applications
	WLAN connected
	Auto-rotate screen
	Adjust screen brightness
	Notification
	Setting up
	Bluetooth activated
	New text or multimedia message
	Alarm activated
	Error occurred or caution required
	Battery power level
	Connected to PC

PREPARATION

TURN ON/OFF THE MACHINE

Pressing “power button” for 3 seconds, you will see the loading screen and then the opening screen.

Pressing “power button” for 3 seconds, you will see a power-off option notice.

Tap “Power off” to turn off your tablet.

Notes:

- Follow all posed warnings and directions from official personal when in areas where the use of wireless devices is restricted, such as airplanes and hospitals.

CHARGE THE BATTERY

Before using the device for the first time, you must charge the battery. You can charge the device with a adapter.

Notes:

1. When your battery is low, the device will display a low battery message, the battery icon will also be empty. If the battery level becomes too low the device will automatically power off. Recharge your battery to continue using your device.
2. If the battery is completely discharged, you can not turn on the device, even with the travel adapter connected. Allow a depleted battery to charge for a few minutes before you try to turn on the device.

INSERT A MEMORY CARD

To store additional multimedia files, you can insert a memory card. Your device accept micro SD memory card with maximum capacities of 32GB (depending on memory card manufacturer and type).

- Insert a memory card with memory card slot.

REMOVE THE MEMORY CARD

Before removing a memory card, first uninstall it for safe removal.

1. In idle mode, select Applications → Settings→ Storage →Uninstall SD card →OK.
2. Remove the memory card.

Notes: Do not remove a memory card while the device is transferring or accessing information, as this could result in loss of data or damage to the memory card or device.

TO INSTALL SIM

When you subscribe to cellular service, you will receive a subscriber identity (SIM) card, with subscription details, such as your personal identification optional services, to use network data services.

- Insert a SIM card with SIM card slot.

Notes:

Do not remove a SIM card while the device's modem power is not turn off.

CHECK RUBBER CONNECTORS

Please make sure that all kinds of rubber connectors havebeen locked tightly before using the tablet PC.

SPECIFICATION

Product Module	7" Tablet PC
Brief Introduction	tri-proof
Chipset	Qualcomm Quad-core 8*25Q 1.2GHz
Built-In OS	Android 4.1.2
RAM Density	1GB DDR2
FLASH MEMORY	16GB
LCM	800*1280 IPS Panel

Touch Panel	Multi Capacitive Touch
Support	3G、 Wi-Fi 、 GPS、 Bluetooth
Camera	Front: 2.0 M Pixel ; Rear: 8.0 M Pixel
Battery	Li-Polymer 7000mAh/3.7V
Connection Slot	SIM Card / MicroSD Card / Micro USB / 30pin USB / Earphone Jack

Part 2 INSTRUCTION

LOCKING / UNLOCKING SCREEN

To operate the tablet PC, swipe the locking screen to unlock.



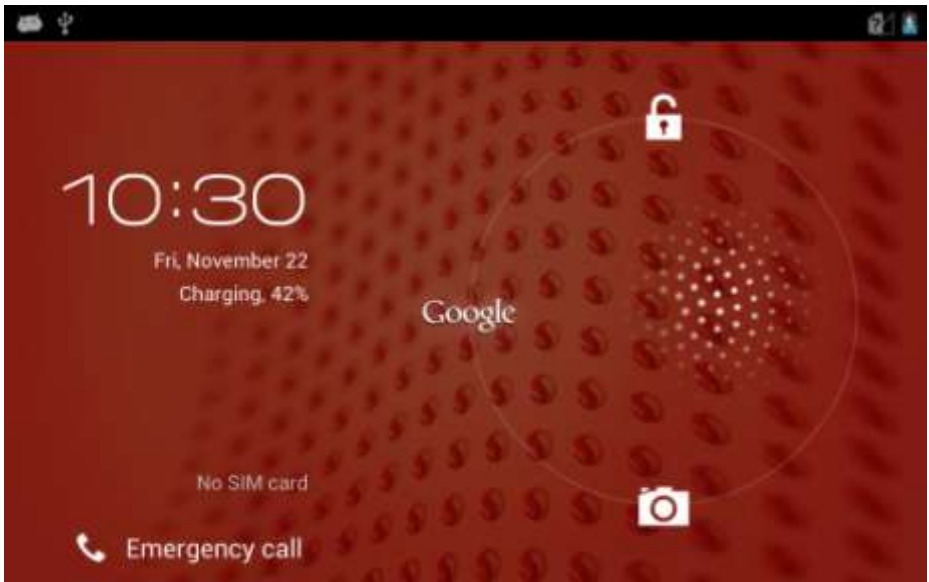

When the screen is unlocked, the camera will be accessible.

GET TO KNOW THE MAIN SCREEN

When the device is in idle mode, you will see the idle screen. The idle screen has multiple panels, scroll left or right to a panel of the idle screen. You can also select a dot at the bottom of the screen to move the corresponding panel of the idle screen directly.

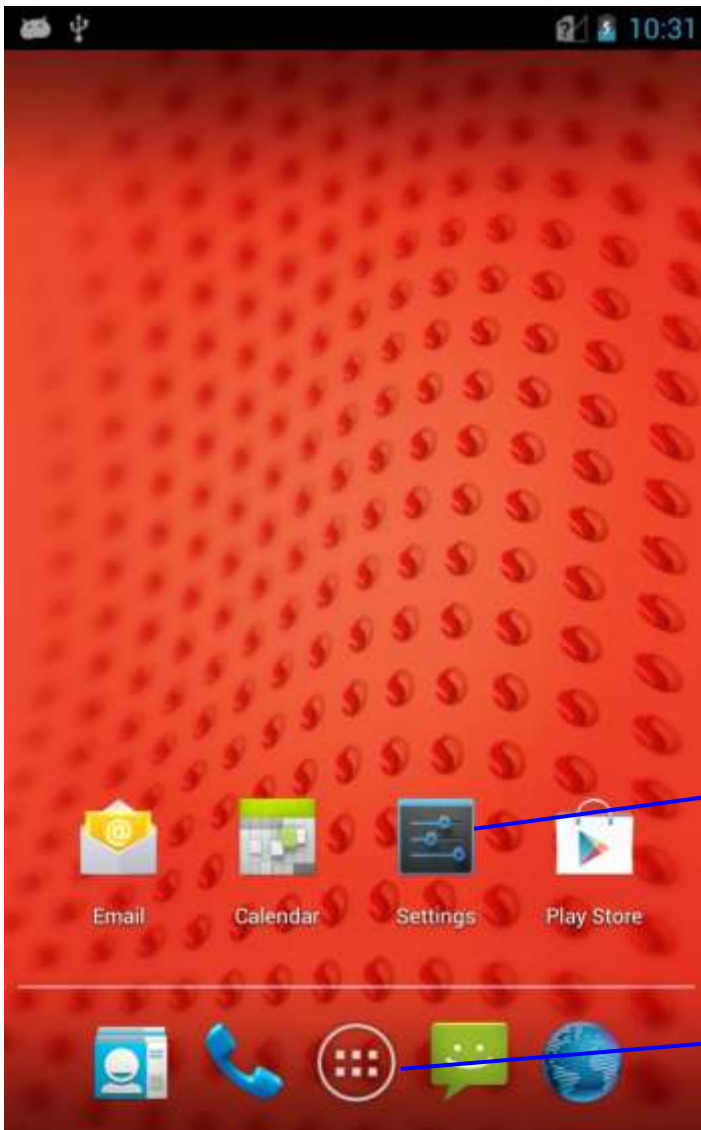

Quick setting

Application screen

SETTING

SYSTEM SETTING

Tap the settings icon to enter system settings.



WIRELESS&NETWORKS

- Wi-Fi

It is for setting wireless device and turning it on/off.

- Bluetooth

It is for setting bluetooth device and turn it on /off.

Note: hotspot mode is supported.

- NFC

Turning on the paring mode, prepare your NFC supported device and swipe the NFC area to detect the device and then it will complete the paring automatically.

- Data usage

Measured by your tablet, your carrier's data usage accounting may different.

- More

It includes two parts about VPN settings and Mobile networks settings.

DEVICE

- Sound

It is for setting volume, notice ring, default notification etc.

- Display

It is for setting brightness, wallpaper, auto-rotate screen, sleep and front size.

- Storage

It is for checking the memory capacity and memory usage status.

- Battery

It is for checking battery use .

- Apps

It is for management application.

PERSONAL

- Location services

It is for setting Google's location service , GPS satellites and Location&Google search.

- Security

It is setting Screen lock, owner info, encrypt tablet etc

- Language & input

It is setting language, default language, personal dictionary , etc.

- Backup & reset

It is for restoring factory setting etc.

SYSTEM

- Date & time

It is for setting date and time.

- Accessibility

It is for setting touch & hold delay etc.

- Developer options

It is for setting USB debugging,etc.

- About tablet

It is for showing some information about tablet.

USB CONNECTION

You must first configure the Storage Mode before transferring file in storage setting.

Use USB cable to connect your phone to a computer, and it will pop up a notification message in the pull down notification bar.

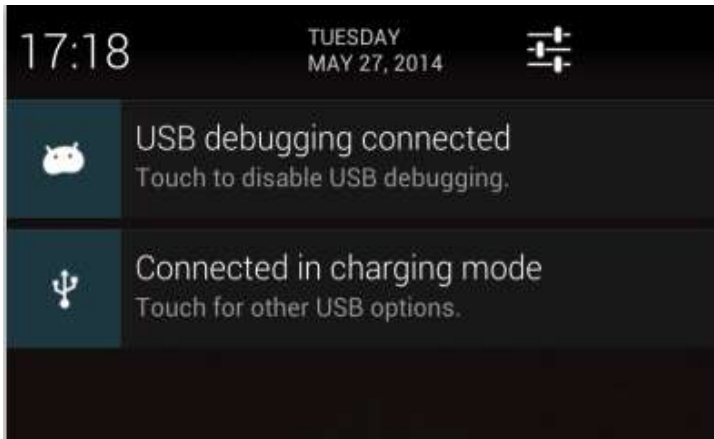

That means that the phone has successfully connected to the computer by USB.(The default connection will be in charging mode)

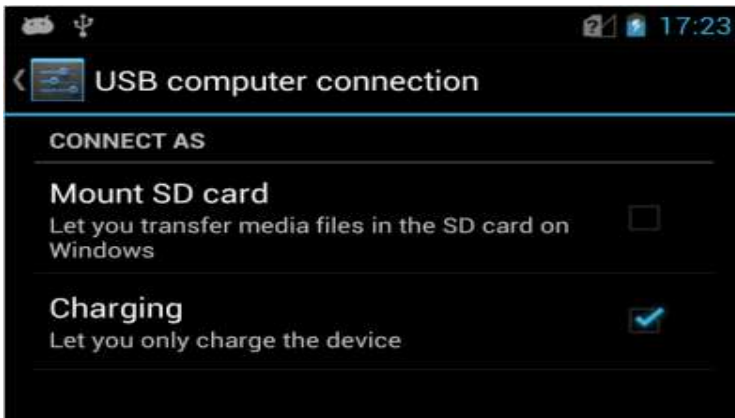

You can manually select the USB storage device, then it can connect to the PC successfully.



POWER OFF

When you do not use the tablet PC, you can press the power button to switch it off.



10:29

 Power off

 Airplane mode
Airplane mode is OFF

 Silent mode
Sound is ON



Email



Calendar



Settings



Play Store



TROUBLE SHOOT

Your device displays network or service error messages.

When you are in areas with weak signals or poor reception, you may lose reception, move to another area and try again.

If “?” icon displaying with 3G signal,take notice the plugging direction for SIM card.

You cannot access some optional without a subscription, contact your service provider for more details.

The touch screen responds slowly or improperly.

If your device has a touch screen and the touch screen is not responding properly, try the following:

1. Remove any protective covers from the touch screen, protective covers may prevent the device from recognizing your inputs and are not recommended for touch screen devices.
2. Ensure that your hands are clean and dry when tapping the touch screen.
3. Restart your device to clear any temporary software bugs.
4. Ensure that your device software is upgraded to the latest version.
5. If the touch screen is scratched or damaged, take it to your service center.

Your device is hot to the touch.

When you use applications that require more power or use applications on your device for an extended period of time, your device may feel hot to the touch, this is normal and should not affect your device’s lifespan or performance.

A connection is not established when you connect the device to a PC.

1. Ensure that the USB cable you are using is compatible with your device.
2. Once connected properly,the charging indicator LED will be red or

green.

3. Ensure that you have the proper drivers installed and updated on your PC.

Reset Tablet: Once it happened to be down or could not power on, Press the Power Key for 10 seconds to reset the tablet.

1/OTG function: Expansion port in the flat side of the fuselage 30pin leads, not the lead in the bottom of the 5pin Microi USB.

2/OTG function and charging can not be used at the same time: When using an external OTG function mouse, keyboard and U disk, this time can not be charged for the tablet.

FCC RF EXPOSURE INFORMATION:

WARNING!! Read this information before using your phone

In August 1986 the Federal Communications Commission (FCC) of the United States with its action in Report and Order FCC 96-326 adopted an updated safety standard for human exposure to radio frequency (RF) electromagnetic energy emitted by FCC regulated transmitters. Those guidelines are consistent with the safety standard previously set by both U.S. and international standards bodies. The design of this phone complies with the FCC guidelines and these international standards. Use only the supplied or an approved antenna. Unauthorized antennas modifications, or attachments could impair call quality, damage the phone, or result in violation of FCC regulations. Do not use the phone with a damaged antenna. If a damaged antenna comes into contact with the skin, a minor burn may result. Please contact your local dealer for replacement antenna.

BODY-WORN OPERATION:

This device was tested for typical body-worn operations with the back of the phone kept 10mm from the body. To comply with

FCC RF exposure requirements, a minimum separation distance of 10mm must be maintained between the user's body and the back of the phone, including the antenna. Third-party belt-clips, holsters and similar accessories containing metallic components shall not be used. Body-worn accessories that cannot maintain 10mm separation distance between the user's body and the back of the phone, and have not been tested for typical body-worn operations may not comply with FCC RF exposure limits and should be avoided.

For more information about RF exposure, please visit the FCC website at www.fcc.gov

Your wireless handheld portable telephone is a low power radio transmitter and receiver. When it is ON, it receives and also sends out radio frequency (RF) signals. In August, 1996, the Federal Communications Commissions (FCC) adopted RF exposure guidelines with safety levels for hand-held wireless phones. Those guidelines are consistent with the safety standards previously set by both U.S. and international standards bodies:

<ANSI C95.1> (1992) / <NCRP Report 86> (1986) / <ICIMIRP> (1996)

Those standards were based on comprehensive and periodic evaluations of the relevant scientific literature. For example, over 120 scientists, engineers, and physicians from universities, government health agencies, and industry reviewed the available body of research to develop the ANSI Standard (C95.1). Nevertheless, we recommend that you use a hands-free kit with your phone (such as an earpiece or headset) to avoid potential exposure to RF energy. The design of your phone complies with the FCC guidelines (and those standards).

Use only the supplied or an approved replacement antenna. Unauthorized antennas, modifications, or attachments could damage the phone and may violate FCC regulations.

NORMAL POSITION:

Hold the phone as you would any other telephone with the antenna pointed up and over your shoulder.

RF Exposure Information:

This product is compliance to FCC RF Exposure requirements and refer to FCC website search for FCC ID: 2ACUBCT7 to gain further information include SAR Values.

This device complies with part 15 of the FCC rules. Operation is subject to the following two conditions:

- (1) this device may not cause harmful interference, and
- (2) this device must accept any interference received, including interference that may cause undesired operation.

NOTE: The manufacturer is not responsible for any radio or TV interference caused by unauthorized modifications to this equipment. Such modifications could void the user's authority to operate the equipment.

NOTE: This equipment has been tested and found to comply with the limits for a Class B digital device, pursuant to part 15 of the FCC Rules. These limits are designed to provide reasonable protection against harmful interference in a residential installation. This equipment generates uses and can radiate radio frequency energy and, if not installed and used in accordance with the instructions, may cause harmful interference to radio communications. However, there is no guarantee that interference will not occur in a particular

installation. If this equipment does cause harmful interference to radio or television reception, which can be determined by turning the equipment off and on, the user is encouraged to try to correct the interference by one or more of the following measures:

- Reorient or relocate the receiving antenna.
- Increase the separation between the equipment and receiver.
- Connect the equipment into an outlet on a circuit different from that to which the receiver is connected.
- Consult the dealer or an experienced radio/TV technician for help

Do not use the device with the environment which below minimum -10°C or over maximum 50°C , the device may not work.

Changes or modifications to this unit not expressly approved by the party responsible for compliance could void the user's authority to operate the equipment.

Ad Hoc function is supported but not able to operate on non-US frequencies.